

A GUIDE TO FIRE & ACOUSTIC DATA FOR COLD-FORMED STEEL FLOOR, WALL & ROOF ASSEMBLIES (June 2013)

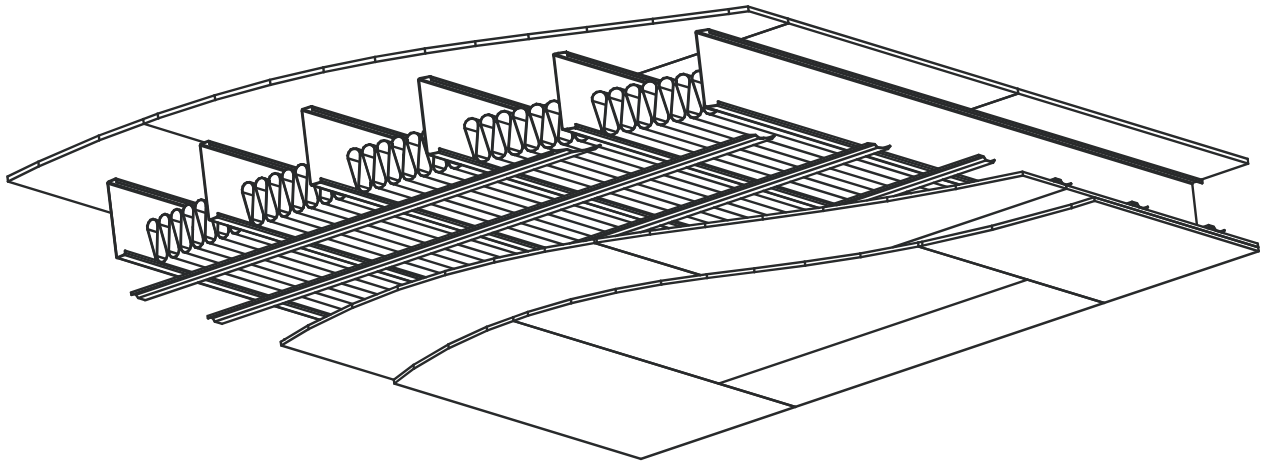

Supported By:



DISCLAIMER

The material in this guide has been prepared as a reference of fire and sound rated lightweight steel framed assemblies. While every effort has been taken to ensure that the material is technically correct, it only offers a brief description of the tested assemblies. It must not be used without first reviewing the source documents of the testing agencies for a full description of the assembly. The Steel Framing Alliance, nor their organization's members, warrant or assume liability for the suitability of the material for any general or particular use.

Please note that some assemblies are constructed with proprietary products that may not be available in all geographical areas. Please consult the source documents of the testing agencies for these details. Where fire rated designs utilize a proprietary steel joist, fluted unit, light gauge steel truss or steel stud, the source column appears shaded and the word proprietary is in bold font to allow ease of identification for an assembly built with a proprietary cold-formed steel product.

Steel Framing Alliance
25 Massachusetts Avenue, NW, Suite 800
Washington, D.C., U.S.A., 20001-7400
Tel: (202) 785-2022
www.steel framing.org

PREFACE

The purpose of this guide is to summarize fire and sound data for steel floor, wall and roof assemblies that are relevant to residential and light commercial construction. Fire data has been compiled from the following six sources:

Underwriters Laboratories of Canada 7 Underwriters Road Toronto, Ontario, Canada M1R 3B4 www.ulc.ca	ULC
National Research Council of Canada Institute for Research in Construction 1200 Montreal Road Ottawa, Ontario, Canada K1A 0R6 www.irc.nrc-cnrc.gc.ca	NRCC
Underwriters Laboratories Inc. 333 Pfingsten Road Northbrook, Illinois, U.S.A. 60062-2096 www.ul.com	UL
Gypsum Association 6525 Belcrest Road. Suite 480 Hyattsville, Maryland, U.S.A. 20782 www.gypsum.org	GA
Factory Mutual Global Research FM Global Corporate Offices 270 Central Avenue Johnston, Rhode Island, U.S.A. 02919-4923 www.fmglobal.com	FM
Intertek Testing Services NA Inc. 545 E. Algonquin Road Suite F Arlington Heights, Illinois, U.S.A. 60005 www.intertek.com www.spec-direct.com	ITS

NOTES

1. ULC Design Numbers (published in the Fire Resistance Directory of Underwriters Laboratories of Canada) and NRCC Report/Assembly Numbers (research publications of the Institute for Research in Construction, National Research Council of Canada) should be referenced when considering steel floor, wall and roof assembly designs in Canadian Building Code jurisdictions.
2. For non-load bearing wall assemblies, steel stud thickness as per ASTM C 645, Standard Specification for Nonstructural Steel Framing Members, where minimum thickness is specified as 0.0179 in. (0.455 mm) before application of protective coating or in conformance with Section 9.
3. UL non-load bearing wall and load bearing wall assemblies provide stud material thickness with a Manufacturers' Standard Gauge (MSG) number. UL's "*BXUV.GuideInfo, Fire Resistance Ratings – ANSI/UL 263*" provides the following thickness tables where an MSG is stated in the fire rated design.

For load-bearing steel studs:

MSG	Minimum bare metal thickness (in.)
20	0.0329
18	0.0428
16	0.0538
14	0.0677

For non-load bearing steel studs:

MSG	Minimum bare metal thickness (in.)
25	0.0179
22	0.0269
20	0.0329
18	0.0428
16	0.0538

4. Both the SFIA and the SSMA code compliance certification programs have developed minimum requirements that must be satisfied in order for a nonstructural stud to be considered an equivalent gauge stud (EQ stud). These criteria are to insure that the EQ stud will perform as well or better than the stud it replaces. A nonstructural EQ stud must meet the following criteria:
 - Have an allowable or nominal bending moment that is at least equal to that of their traditional stud counterpart as listed in ASTM C645, Table 2.
 - Must have developed and published composite limiting height tables in accordance with ICC-ES AC86 – 2010.

NOTES (continued)

- Must have published screw data (shear and pullout) that is equal or greater than the traditional ASTM C645 stud.
- Must pass the screw penetration test in ASTM C645.
- Must meet the corrosion protection requirements of ASTM C645.

Fire assemblies that have EQ studs listed within the assembly are indicated with the following symbol: **EQ** EQ studs can also be used in assemblies if they meet the minimum physical requirements described within the assembly.

Products delivered to the jobsite with SFIA or SSMA labels on the packaging assure the user that the studs are code compliant, meet the requirements above, and were subjected to independent third party certification to these requirements.

5. The majority of sound data that has been incorporated into this guide were based on the following report:

Warnock, A.C.C., *Estimation of Sound Transmission Class and Impact Insulation Class Rating for Steel Framed Assemblies*, Report No. B3436.1 Revised, Institute for Research in Construction, National Research Council of Canada, Ottawa, Ontario, Canada, November 2008.

The above report has surveyed existing published sound test reports denoted in the source column by an alphanumeric acoustic test identifier. Letter prefixes in the identifier denote various acoustic testing laboratories. The report also provides numerous acoustic “estimates” and these have been noted with an asterisk that refers to the above report, i.e., Warnock (2008). The report is available as a Steel Framing Alliance Research Report (RP08-7) from their website (<http://store.steel framingalliancestore.com/esofsotrclan.html>) as a free download in the form of an Adobe Acrobat file. Acoustic estimates were made with an acoustic “SOund Classification RATing ESTimator” called “Socrates” that is available from the National Research Council of Canada via the following website:

<http://archive.nrc-cnrc.gc.ca/eng/ibp/irc/software.html>

Further information on “Socrates” is also available via the following website:

<http://www.alfwarnock.info/sound/socindex.html>

Acoustic data in some cases appears with the following codes to denote a material:

AIR – a gap in the construction (a layer of air with thickness)

NOTES (continued)

CAR-UND – carpet and underpad
CEMBRD – cement board (with thickness)
CER-PAD – ceramic tile and rubber pad
G – gypsum board (with thickness)
GFB – glass fiber batts (with thickness)
NI – no insulation
NRC – no resilient metal channels
RC - resilient metal channels
RFB – rock fiber (mineral wool) batts (with thickness)

6. Information on UL fire rated cold-formed steel truss assemblies is available from the Cold-Formed Steel Council via the following webpage:

http://www.cfsc.sbcindustry.com/docs/Fire_Assemblies_SSC.pdf

7. Details of UL and ULC listings for fire rated floor, wall and truss assemblies can be downloaded from the website of UL and ULC by using the alphanumeric fire identifier within a keyword search. For example, on the UL website enter the following information:

- go to UL website at: <http://www.ul.com/global/eng/pages/>

- click on “Online Certifications Directory” located at the bottom, right side of webpage

- type in alphanumeric fire identifier, for example “L568” in keyword box and click on “Search”

- go to row with “Design No. L568” and click on “[BXUV.L568](#)”

Similarly for the ULC website enter the following information:

- go to ULC website at: <http://www.ul.com/canada/eng/pages/index.jsp>

- click on “ULC Online Directories” located along left side of webpage

- in “Keyword” type in alphanumeric fire identifier, for example “M511” in keyword box and click on “Search”

- go to row with “Design No. M511” and click on “[BXUVC.M511](#)”

8. UL Floor and Load Bearing Wall Designs using cold-formed steel joists and studs can be used for Canadian application without a Load Restriction, i.e., a “Load Restricted Factor” equal to 1.00. Details regarding this restricted load use condition have been added to “*BXUV7.GuideInfo, Fire Resistance Ratings - CAN/ULC-S101 Certified for Canada*”. The percent load reductions in Table 1 of “*BXUV7.GuideInfo*” for typical assemblies are based upon loading calculated in

NOTES (continued)

accordance with the working stress design method as compared to loading calculated in accordance with the limit states design method. The fire resistance ratings for floors supported by cold-formed steel channels and walls supported by cold-formed steel studs do not have a Load Restriction Factor because the associated loads in Canada and the U.S. are based on the same standard: CSA S136-07, “North American Specification for the Design of Cold-Formed Steel Structural Members”, and ANSI/AISI S100-07, “North American Specification and Commentary for the Design of Cold-Formed Steel Structural Members”.

9. As per UL’s “*BXUV.GuideInfo, Fire Resistance Ratings – ANSI/UL 263*” and ULC’s “*BXUVC GuideInfo, Fire Resistance Ratings (Guide No. 40 U18)*” the dimensions and thickness (gauge) of steel studs and joists are minimums. The hourly ratings apply when the steel studs and joists are larger in thickness (heavier gauge) and/or have larger dimensions than specified in a design, or when the member spacing is less than what was tested.

ACKNOWLEDGEMENTS

The Steel Framing Alliance acknowledges Bill Kraft of the Steel Framing Alliance and George Frater of the Canadian Steel Construction Council as the Primary Authors of the first edition of this guide, which was published in 2004.

The Steel Framing Alliance is grateful to George Frater of the Canadian Steel Construction Council for his ongoing effort to keep this guide current and to serve as Primary Author of each of the updated editions, which were published in 2005, 2006, 2007, 2009, 2012 and 2013.

The Steel Framing Alliance also appreciates the guidance and feedback provided to the Primary Author by the members of the Fire and Acoustic Task Group of the Cold-Formed Steel Engineers Institute and more recently from a “Technical Review Board” composed of four steel industry members.

Acknowledgement is also made for the financial support provided by the Steel Stud Manufacturers Association for the NRCC Phase II joint research project on the Fire and Acoustical Performance of Floor Assemblies.

TABLE OF CONTENTS

DISCLAIMER	ii
PREFACE	iii
NOTES	iv
ACKNOWLEDGEMENTS	viii
FLOOR/CEILING ASSEMBLIES	1
Underwriters Laboratories of Canada	2
Underwriters Laboratories Inc. for Canadian Application	10
National Research Council of Canada	11
Underwriters Laboratories Inc	18
Gypsum Association	43
Factory Mutual Research	48
NON-LOAD BEARING WALL ASSEMBLIES	50
Underwriters Laboratories of Canada	51
Non-Load Bearing Shaft Walls	67
Non-Load Bearing Chase Walls	74
Non-Load Bearing Area Separation Walls	77
National Research Council of Canada	79
Underwriters Laboratories Inc.	81
Non-Load Bearing Shaft Walls	102
Non-Load Bearing Chase Walls	113
Non-Load Bearing Area Separation Walls	118
Gypsum Association	121
Factory Mutual Research	123
Intertek Testing Services NA Inc.	124
LOAD BEARING WALL ASSEMBLIES	128
Underwriters Laboratories of Canada	129
Underwriters Laboratories Inc. for Canadian Application	132
National Research Council of Canada	133
Underwriters Laboratories Inc.	137
Gypsum Association	146
ROOF/CEILING ASSEMBLIES	147
Underwriters Laboratories of Canada	148
Underwriters Laboratories Inc.	149

FLOOR/CEILING ASSEMBLIES

Floor/Ceiling - Underwriters Laboratories of Canada

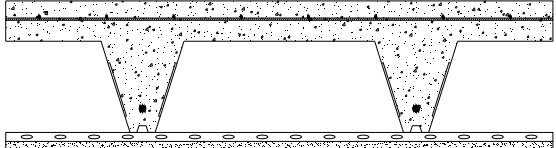
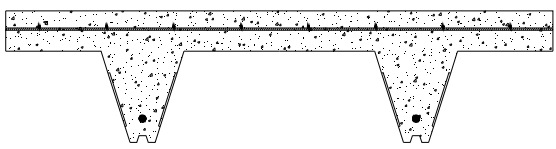
Source	Description	Fire Resistance Rating	Sound Transmission Class	Impact Insulation Class
ULC D500 NGC Testing Services™	<ul style="list-style-type: none"> min. 90 mm concrete topping 152 mm by 152 mm MW18.7/MW18.7 welded steel wire mesh steel reinforcing bar with 40 mm concrete cover composite galvanized fluted units, proprietary ComSlab® 210, 203 mm deep or ComSlab® 225, 225 mm deep with a min. design thickness of 0.953 mm by Bailey Metal Products Ltd. furring channels spaced 406 mm o.c. 1 layer of 15.8 mm gypsum board on ceiling side <p>* for steel deck span > 10 m ** for steel deck span ≤ 10m</p>			
		1-½ h * 2 h **	56 60 (RFB 150mm CER-PAD)	60 (CAR-UND) 54 (RFB 150mm CER-PAD)
ULC F909	<ul style="list-style-type: none"> 64 mm concrete topping for 1 h and 90 mm for 1½ h 152 mm by 152 mm MW18.7/MW18.7 welded steel wire mesh steel reinforcing bar with 40 mm concrete cover composite galvanized fluted units, proprietary ComSlab® 210, 203 mm deep or ComSlab® 225, 225 mm deep with a min. design thickness of 0.953 mm by Bailey Metal Products Ltd. steel deck span ≤ 10m 			
		1 h 1-½ h	-	-

Floor/Ceiling - Underwriters Laboratories of Canada

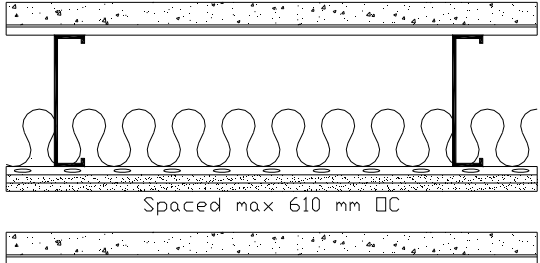
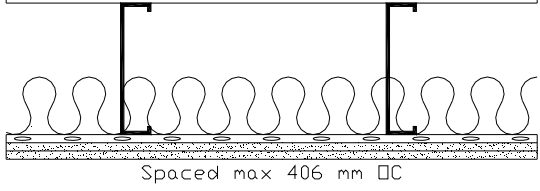
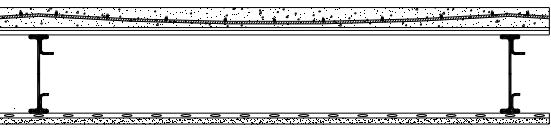
Source	Description	Fire Resistance Rating	Sound Transmission Class	Impact Insulation Class
ULC I523 a) TLF-02-051a b) IIF-02-032	<ul style="list-style-type: none"> 35 mm concrete 0.38 mm thick steel deck with 15.9 mm deep corrugations 203 mm deep steel joist with 1.15 mm material thickness and spaced at 406 mm o.c. or 610 mm o.c. optional resilient metal channels spaced 610 mm o.c. optional 90 mm mineral wool or glass fibre batt insulation 2 layers of 12.7 mm gypsum board on ceiling side 			
				
		1 h	610 mm joist spacing	
			65* (GFB RC) 60* (NI RC)	29* (GFB RC) 30* (NI RC)
	406 mm joist spacing			
	66 ^a (GFB RC) 60* (NI RC)	34 ^b (GFB RC) <30* (NI RC)		
ULC I525	<ul style="list-style-type: none"> 56 mm concrete slab with 150 mm by 150 mm MW18.7 x MW18.7 welded wire fabric on 22 MSG thick steel deck with 14 mm deep corrugations 205 mm deep, min. 16 ga. thick proprietary composite steel joist, TotalJoist™ by iSPAN Systems LP spaced at 1220 mm o.c. resilient channels spaced 610 mm o.c. 1 layer of 16 mm gypsum board on ceiling side 			
		1 h 2 h	50 to 56	25 to 68

* Estimated value as per Warnock (2008)

Floor/Ceiling - Underwriters Laboratories of Canada

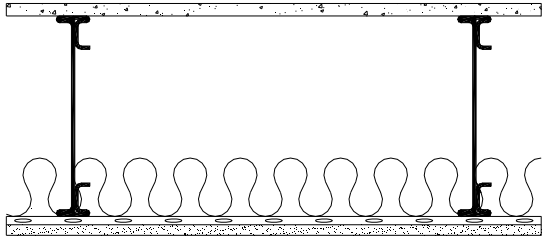
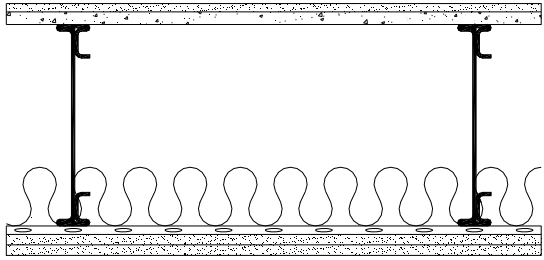
Source	Description	Fire Resistance Rating	Sound Transmission Class	Impact Insulation Class
ULC 1526	<ul style="list-style-type: none"> subfloor of 19 mm thick tongue-and-groove cement-fibre board designated "Structo-Crete" 300 mm deep proprietary steel joist, TotalJoist™ by iSPAN Systems LP with 1.2 mm material thickness and spaced at 600 mm o.c. resilient metal channels spaced 300 mm o.c. 92 mm thick glass-fibre batt insulation 1 layer of 15.9 mm gypsum board on ceiling side 			
		1 h	56 to 64*	-
ULC 1527	<ul style="list-style-type: none"> subfloor of 19 mm thick tongue-and-groove cement-fibre board designated "Structo-Crete" topped with 12.7 mm thick gypsum board (System A) or 19 mm thick floor topping mixture (System B) 300 mm deep proprietary steel joist, TotalJoist™ by iSPAN Systems LP with 1.2 mm material thickness and spaced at 600 mm o.c. resilient metal channels spaced 300 mm o.c. 92 mm thick glass-fibre batt insulation 2 layers of 15.9 mm gypsum board on ceiling side 			
		2 h	61**	-

* Brunette, N.L., Airborne Sound Transmission Loss and Impact Sound Transmission Measurements Performed on One Floor Assembly, NRC Client Report B-3454.1, National Research Council of Canada, Ottawa, Ontario, Canada, 2007.

** Brunette, N.L., Airborne Sound Transmission Loss and Impact Sound Transmission Measurements Performed on One Floor Assembly, NRC Client Report B-3454.6, National Research Council of Canada, Ottawa, Ontario, Canada, 2007.

Floor/Ceiling - Underwriters Laboratories of Canada

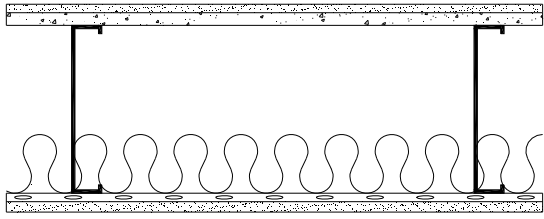
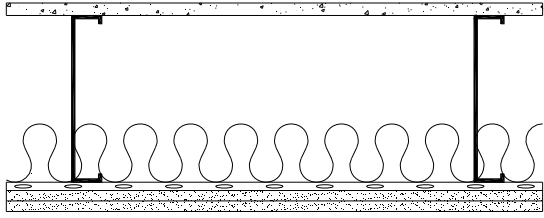
Source	Description	Fire Resistance Rating	Sound Transmission Class	Impact Insulation Class
ULC I528	<ul style="list-style-type: none"> • 1-½ hours - subfloor of 19 mm thick tongue-and-groove cement-fibre board designated “Fortacrete” • 2 hours - subfloor of 19 mm thick tongue-and-groove cement-fibre board designated “Fortacrete” topped with 12.7 mm thick gypsum board (System A) or 19 mm thick floor topping mixture (System B) • 254 mm deep with 1.6 mm material thickness and spaced at 610 mm o.c. • resilient metal channels spaced 305 mm o.c. • 92 mm thick glass-fibre batt insulation • 1 layer of 15.9 mm gypsum board on ceiling side <p>* 96% load restriction</p>		-	-
ULC I529	<ul style="list-style-type: none"> • subfloor of 19 mm thick tongue-and-groove cement-fibre board designated “Fortacrete” • 254 mm deep with 1.6 mm material thickness and spaced at 610 mm o.c. • resilient metal channels spaced 305 mm o.c. • 92 mm thick glass-fibre batt insulation • 2 layers of 15.9 mm gypsum board on ceiling side <p>* 96% load restriction</p>		-	-

Floor/Ceiling - Underwriters Laboratories of Canada

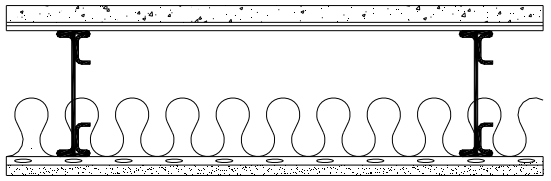
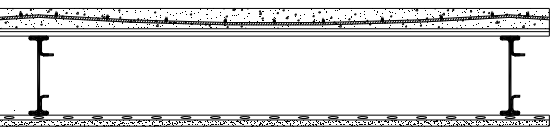
Source	Description	Fire Resistance Rating	Sound Transmission Class	Impact Insulation Class
ULC 1530	<ul style="list-style-type: none"> min. 25.4 mm floor topping mixture min. 14 mm deep, 20 MSG corrugated fluted steel deck 190 mm deep, min. 20 GA thick proprietary steel joist, TotalJoist™ by iSPAN Systems LP spaced at 610 mm o.c. resilient metal channels spaced 305 mm o.c. 89 mm thick glass fibre insulation 1 layer of 16 mm gypsum board on ceiling side 			
		1½ h 2 h	59 to 62*	41 to 65*
ULC 1532	<ul style="list-style-type: none"> 56 mm concrete slab with 150 mm by 150 mm MW18.7 x MW18.7 welded wire fabric on 22 MSG steel deck with 14 mm deep corrugations 205 mm deep, min. 16 ga. thick proprietary composite steel joist, TotalJoist™ by iSPAN Systems LP spaced at 1220 mm o.c. resilient channels spaced 610 mm o.c. 1 layer of 16 mm gypsum board on ceiling side 			
		1 h 2 h 3 h	50 to 56	25 to 68

* STC and IIC ratings based on 254 mm deep joists and deeper. A range of STC and IIC ratings available depending on system type and finished floor type, contact iSPAN Systems LP for more information.

Floor/Ceiling - Underwriters Laboratories of Canada

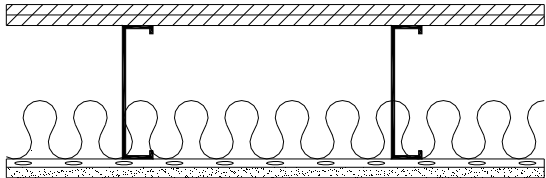
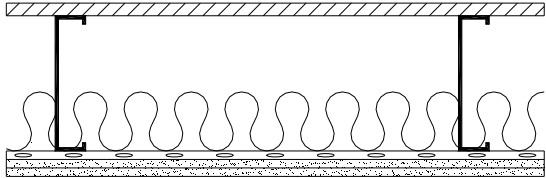
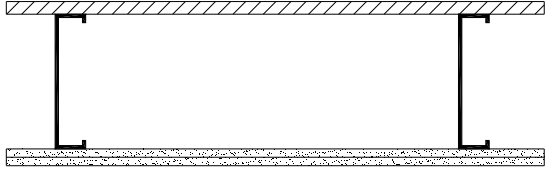
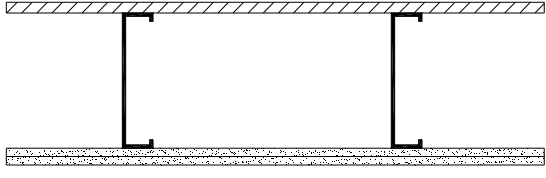
Source	Description	Fire Resistance Rating	Sound Transmission Class	Impact Insulation Class	
ULC M511	<ul style="list-style-type: none"> subfloor of 15.9 mm plywood and finish floor of 15.9 mm wood structural panels 203 mm deep steel joist with 1.15 mm material thickness and spaced at 406 mm o.c. resilient metal channels spaced 406 mm o.c. 90 mm thick mineral wool batt insulation 1 layer of 15.9 mm gypsum board on ceiling side 		45 min	53*	46*
	<ul style="list-style-type: none"> subfloor of 19 mm plywood 203 mm deep steel joist with 1.15 mm material thickness and spaced at 610 mm o.c. resilient metal channels spaced 406 mm o.c. 90 mm thick glass fibre batt insulation 2 layers of 12.7 mm gypsum board on ceiling side 		45 min	52*	45*
	<ul style="list-style-type: none"> subfloor of 19 mm plywood 203 mm deep steel joist with 1.15 mm material thickness and spaced at 610 mm o.c. 2 layers of 12.7 mm gypsum board on ceiling side 		45 min	<40*	<40*
	<ul style="list-style-type: none"> subfloor of 15.9 mm plywood 203 mm deep steel joist with 1.15 mm material thickness and spaced at 406 mm o.c. 2 layers of 12.7 mm gypsum board on ceiling side 		1 h	<40*	<40*

* Estimated value as per Warnock (2008)

Floor/Ceiling - Underwriters Laboratories of Canada

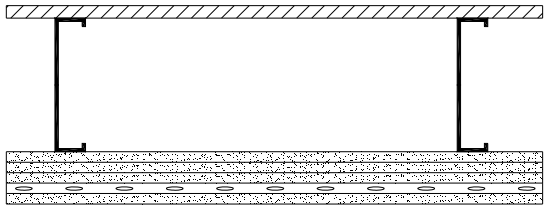
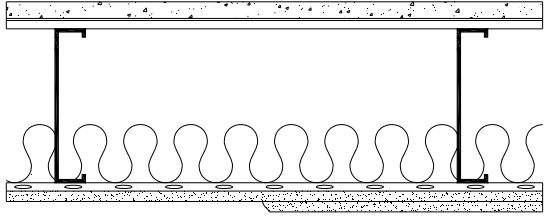
Source	Description	Fire Resistance Rating	Sound Transmission Class	Impact Insulation Class
<p>ULC M514</p> <p>a) NGC5004021 b) NGC7004068 c) NGC7004069</p>	<ul style="list-style-type: none"> • subfloor of 19 mm plywood • 203 mm deep steel joist with 1.07 mm material thickness and spaced at 610 mm o.c. • 4 layers of 15.9 mm Type X gypsum board on ceiling side • resilient metal channels spaced 610 mm o.c. and applied perpendicular to joists over third layer of gypsum board 			
		2 h	48 ^a	37 ^b 60 ^c (CAR-UND)
<p>ULC M518</p>	<ul style="list-style-type: none"> • 25 mm min. floor topping mixture with 25 MPa compressive strength • 14 mm min. deep, 22 gauge corrugated steel deck • 235 mm x 16 gauge steel joist spaced at 610 mm o.c. • resilient channels spaced 305 mm o.c. • 90 mm mineral wool or glass fiber batt insulation • 1½ hour - 1 layer of 15.9 mm gypsum board on ceiling side • 2 hour – 2 layers of 15.9 mm gypsum board on ceiling side 			
		1 h 1½ h 2h	-	-

Floor/Ceiling - Underwriters Laboratories of Canada

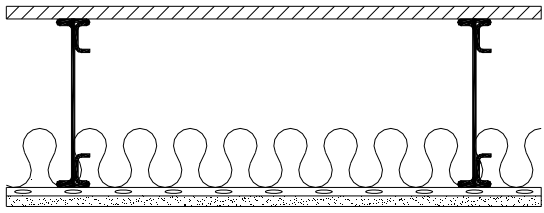
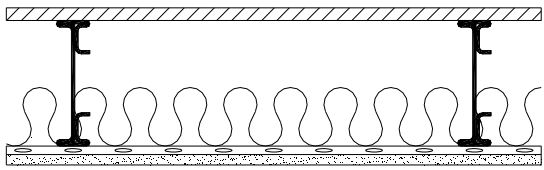
Source	Description	Fire Resistance Rating	Sound Transmission Class	Impact Insulation Class
ULC M520	<ul style="list-style-type: none"> subfloor of 19 mm plywood or OSB with optional min. 19 mm floor topping mixture (System A). In lieu of plywood or OSB subfloor, 22 mm min. deep, 0.76 mm thick corrugated steel deck with min. 48 mm normal weight concrete (System C) min. 254 mm deep proprietary steel joist, TotalJoist™ by iSPAN Systems LP with 1.2 mm material thickness and spaced at 610 mm o.c. resilient metal channels spaced 300 mm o.c. 75 mm thick mineral wool batt insulation 1 layer of 16 mm gypsum board on ceiling side 			
		1 h	50 to 63*	38 to 72*
ULC M521	<ul style="list-style-type: none"> subfloor of 19 mm plywood, OSB or tongue-and-groove cement-fibre board designated "Armoroc Panel" with optional min. 19 mm floor topping mixture min. 190 mm deep proprietary steel joist, TotalJoist™ by iSPAN Systems LP with 20 ga. material thickness and spaced at 610 mm o.c. resilient metal channels spaced 305 mm o.c. 89 mm thick glass fibre batt insulation 1 layer of 16 mm gypsum board on ceiling side 			
		1 h	50*	43*

* STC and IIC ratings based on 254 mm deep joists and deeper. A range of STC and IIC ratings available depending on system type and finished floor type, contact iSPAN Systems LP for more information.

Floor/Ceiling - Underwriters Laboratories Inc. for Canadian Applications

As per Technical Note no. 8, UL Floor/Ceiling and Load Bearing Wall assemblies using cold-formed steel joists and studs can be used for Canadian application. Details regarding this condition are given in “*BXUV7.GuideInfo, Fire Resistance Ratings - CAN/ULC-S101 Certified for Canada*”. UL Floor/Ceiling assemblies that can be used for Canadian application as per BXUV7 are listed below and the relevant assemblies are noted with a BXUV7 symbol in the 1st column of the section showing UL Floor/Ceiling assemblies (see pages 18 to 42).

G533	G559	L549
G534	G560	L551
G540	G563	L552
G541	G564	L556
G542	G565	L559
G543	G567	L560
G545	G568	L564
G546	G571	L565
G549	G574	L567
G551	L524	L568
G552	L527	L573
G553	L543	L599

Floor/Ceiling – National Research Council of Canada

The following pages present floor/ceiling assemblies fire tested at NRCC during two multi industry (steel, wood, gypsum and insulation) fire testing programs that are reported on in two fire test reports, namely IR No. 764 (May 1998) and RR No. 184 (March 2005). The fire test report nos. appear in the source column and are followed by a “FF” fire test no. used in the report. Relevant NRCC acoustic reports are also listed below and these reference documents deal with acoustic data, i.e., values of Sound Transmission Class and Impact Insulation Class that have been established as an estimated value or from an acoustic test where the acoustic test no. appears in the source column.

NRCC IR-764 data for FF22 to FF27 (see pages 12 and 13)

Reference (fire data):

Sultan, M.A., Séguin, Y.P. and Leroux, P., *Results of Fire Resistance Tests on Full-Scale Floor Assemblies, IRC Internal Report No. 764 (IR-764)*, National Research Council of Canada, Ottawa, Ontario, Canada, May 1998.

References (acoustic data):

Warnock, A.C.C. and Birta, J.A., *Summary Report for Consortium on Fire Resistance and Sound Insulation of Floors: Sound Transmission Class and Impact Insulation Class Results, IRC Internal Report No. 766*, National Research Council of Canada, Ottawa, Ontario, Canada, April 1998.

** Warnock, A.C.C., *Sound Transmission Estimates for Steel-Framed Floor Assemblies*, Institute for Research in Construction, National Research Council of Canada, Ottawa, Ontario, Canada, January 12, 2000.

* Warnock, A.C.C., *Estimation of Sound Transmission Class and Impact Insulation Class Rating for Steel Framed Assemblies*, Report No. B3436.1 Revised, Institute for Research in Construction, National Research Council of Canada, Ottawa, Ontario, Canada, November 2008.

Birta, J.A. and Warnock, A.C.C., *Airborne and Impact Sound Transmission Measurements Performed on Specimen B1363-1*, National Research Council of Canada, Ottawa, Ontario, Canada, 2001.

Birta, J.A. and Warnock, A.C.C., *Airborne and Impact Sound Transmission Measurements Performed on Specimen B1363-2*, National Research Council of Canada, Ottawa, Ontario, Canada, 2001.

NRCC RR-184 data for FF37 to FF74 (see pages 14 to 17)

Reference (fire data):

Sultan, M.A., Latour, J.C., Leroux, P., Monette, R.C., Séguin, Y.P. and Henrie, J.P., *Results of Fire Resistance Tests on Full-Scale Floor Assemblies – Phase II, Research Report No. 184 (RR-184)*, Institute for Research in Construction, National Research Council of Canada, Ottawa, Ontario, Canada, March 2005.

References (acoustic data):

Warnock, A.C.C., *Summary Report for Consortium on Fire Resistance and Sound Insulation of Floors: Sound Transmission and Impact Insulation Data, Research Report No. 169 (RR-169)*, Institute for Research in Construction, National Research Council of Canada, Ottawa, Ontario, Canada, January 2005.

* Warnock, A.C.C., *Estimation of Sound Transmission Class and Impact Insulation Class Rating for Steel Framed Assemblies*, Report No. B3436.1 Revised, Institute for Research in Construction, National Research Council of Canada, Ottawa, Ontario, Canada, November 2008.

Floor/Ceiling – National Research Council of Canada

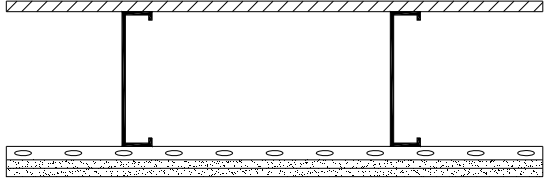
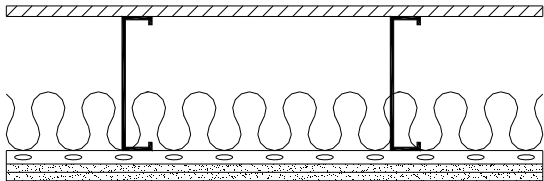
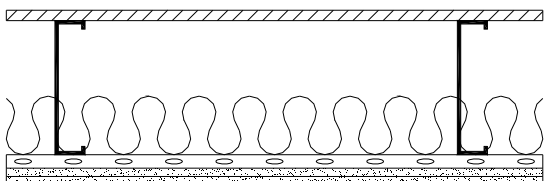
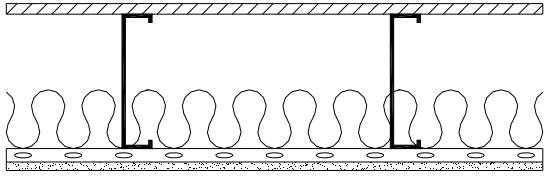
Source	Description	Fire Endurance	Sound Transmission Class	Impact Insulation Class	
NRCC IR-764 FF22	<ul style="list-style-type: none"> subfloor of 15.9 mm plywood 203 mm deep steel joist with 1.22 mm material thickness and spaced at 406 mm o.c. resilient metal channels spaced 406 mm o.c. 2 layers of 12.7 mm Type X gypsum board on ceiling side 		74 min	<50*	<40* 60**
NRCC IR-764 FF23 a) TLF-01-003a b) TLF-01-005a c) IIF-00-036 d) IIF-01-001	<ul style="list-style-type: none"> subfloor of 15.9 mm plywood 203 mm deep steel joist with 1.22 mm material thickness and spaced at 406 mm o.c. resilient metal channels spaced 406 mm o.c. 90 mm thick glass fibre insulation 2 layers of 12.7 mm Type X gypsum board on ceiling side 		68 min	49 ^a 52 ^b (CAR-UND)	39 ^c 70 ^d (CAR-UND)
NRCC IR-764 FF24	<ul style="list-style-type: none"> subfloor of 15.9 mm plywood 203 mm deep steel joist with 1.22 mm material thickness and spaced at 610 mm o.c. resilient metal channels spaced 406 mm o.c. 90 mm thick glass fibre insulation 2 layers of 12.7 mm Type X gypsum board on ceiling side 		69 min	49*	42* 62**
NRCC IR-764 FF25	<ul style="list-style-type: none"> subfloor of 15.9 mm plywood 203 mm deep steel joist with 1.22 mm material thickness and spaced at 406 mm o.c. resilient metal channels spaced 406 mm o.c. 90 mm thick mineral fibre insulation 1 layer of 12.7 mm Type X gypsum board on ceiling side 		46 min	45*	39* 64**
* Estimated value as per Warnock (2008)		** With carpet and pad (Warnock, 2000)			

Floor/Ceiling – National Research Council of Canada

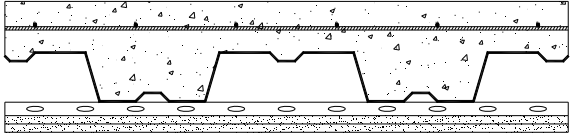
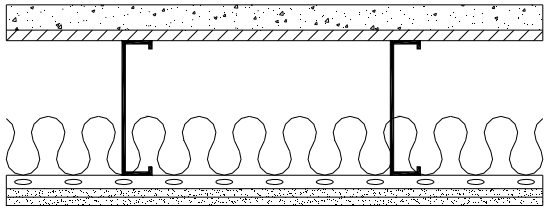
Source	Description	Fire Endurance	Sound Transmission Class	Impact Insulation Class
NRCC IR-764 FF26 a) TLF-97-109a b) IIF-97-049	<ul style="list-style-type: none"> 76 mm composite concrete slab with 152 mm by 152 mm MW3.8/MW3.8 welded steel wire mesh on 0.91 mm thick steel deck with 76 mm deep corrugations resilient metal channels spaced 406 mm o.c. 2 layers of 12.7 mm Type X gypsum board on ceiling side 			
		105 min	57 ^a	36 ^b 70 ^{**}
NRCC IR-764 FF27	<ul style="list-style-type: none"> 38 mm concrete topping subfloor of 15.9 mm plywood 203 mm deep steel joist with 1.22 mm material thickness and spaced 406 mm o.c. resilient metal channels spaced 406 mm o.c. 90 mm thick glass fibre insulation 2 layers of 12.7 mm Type X gypsum board on ceiling side 			
		60 min	66 [*]	36 [*] 70 ^{**}
* Estimated value as per Warnock (2008)		** With carpet and pad (Warnock, 2000)		

Floor/Ceiling – National Research Council of Canada

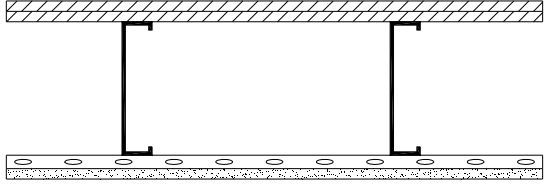
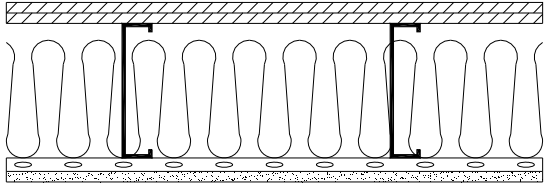
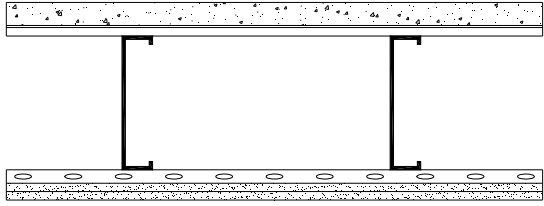
Source	Description	Fire Endurance	Sound Transmission Class	Impact Insulation Class
NRCC RR-184 FF37	<ul style="list-style-type: none"> • 2 layers of 15.9 mm plywood subfloor • 203 mm deep steel joist with 1.22 mm material thickness and spaced at 406 mm o.c. • resilient metal channels spaced 406 mm o.c. • 1 layer of 15.9 mm Type X gypsum board on ceiling side 			
		38 min	-	-
NRCC RR-184 FF38	<ul style="list-style-type: none"> • 2 layers of 15.9 mm plywood subfloor • 203 mm deep steel joist with 1.22 mm material thickness and spaced at 406 mm o.c. • resilient metal channels spaced 406 mm o.c. • 178 mm thick rock fibre insulation • 1 layer of 15.9 mm Type X gypsum board on ceiling side 			
		53 min	-	-
NRCC RR-184 FF40 a) TLF-03-011a b) IIF-03-005	<ul style="list-style-type: none"> • 35 mm concrete • 0.38 mm thick steel deck with 15.9 mm deep corrugations • 203 mm deep steel joist with 1.22 mm material thickness and spaced at 406 mm o.c. • resilient metal channels spaced 406 mm o.c. • 2 layers of 12.7 mm Type X gypsum board on ceiling side 			
		75 min	62 ^a	32 ^b

Floor/Ceiling – National Research Council of Canada

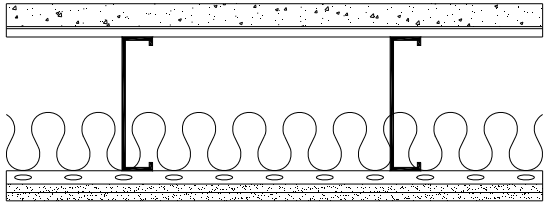
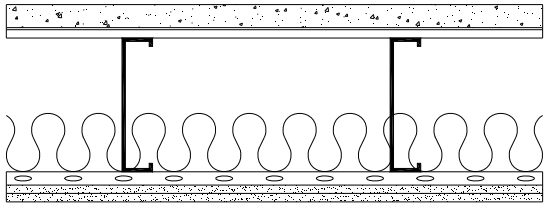
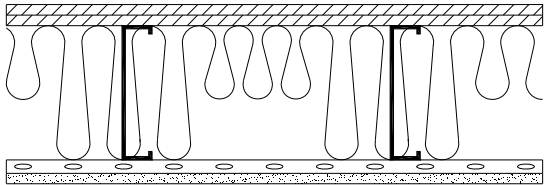
Source	Description	Fire Endurance	Sound Transmission Class	Impact Insulation Class
NRCC RR-184 FF43 a) TLF-03-005a b) IIF-03-003	<ul style="list-style-type: none"> 35 mm concrete 0.38 mm thick steel deck with 15.9 mm deep corrugations 203 mm deep steel joist with 1.22 mm material thickness and spaced at 406 mm o.c. resilient metal channels spaced 406 mm o.c. 90 mm thick glass fibre insulation 2 layers of 12.7 mm Type X gypsum board on ceiling side 			
		68 min	68 ^a	36 ^b
NRCC RR-184 FF44 a) TLF-02-051a b) IIF-02-032	<ul style="list-style-type: none"> 35 mm concrete 0.38 mm thick steel deck with 15.9 mm deep corrugations 203 mm deep steel joist with 1.22 mm material thickness and spaced at 406 mm o.c. resilient metal channels spaced 610 mm o.c. 89 mm thick glass fibre insulation 2 layers of 12.7 mm Type X gypsum board on ceiling side 			
		61 min	66 ^a	34 ^b
NRCC RR-184 FF50 a) TLF-04-029a b) IIF-04-016	<ul style="list-style-type: none"> 2 layers of 15.5 mm plywood subfloor 203 mm deep steel joist with 1.22 mm material thickness and spaced at 406 mm o.c. 91 mm thick cellulose fibre insulation on joist sides and 112 mm on underside of subfloor resilient metal channels spaced 406 mm o.c. 1 layer of 12.7 mm Type X gypsum board on ceiling side 			
		63 min	51 ^a	45 ^b

Floor/Ceiling – National Research Council of Canada

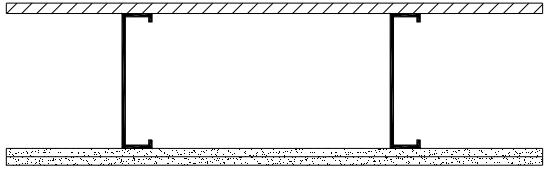
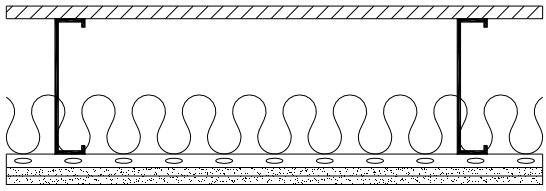
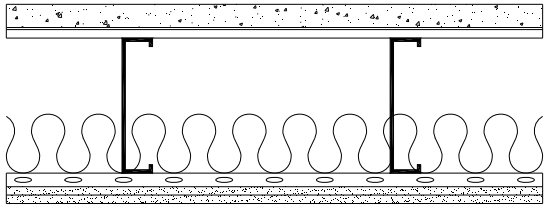
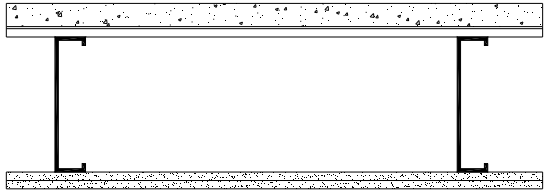
Source	Description	Fire Endurance	Sound Transmission Class	Impact Insulation Class
NRCC RR-184 FF51	<ul style="list-style-type: none"> subfloor of 15.5 mm plywood 203 mm deep steel joist with 1.22 mm material thickness and spaced at 406 mm o.c. 2 layers of 12.7 mm Type X gypsum board on ceiling side 			
		66 min	-	-
NRCC RR-184 FF52	<ul style="list-style-type: none"> subfloor of 19 mm plywood 203 mm deep steel joist with 1.22 mm material thickness and spaced at 610 mm o.c. 89 mm thick glass fibre insulation resilient metal channels spaced 610 mm o.c. 2 layers of 12.7 mm Type X gypsum board on ceiling side 			
		52 min	-	-
NRCC RR-184 FF53 a) TLF-03-007a b) IIF-03-004	<ul style="list-style-type: none"> 35 mm concrete 0.38 mm thick steel deck with 15.9 mm deep corrugations 203 mm deep steel joist with 1.22 mm material thickness and spaced at 406 mm o.c. resilient metal channels spaced 406 mm o.c. 89 mm thick rock fibre insulation 2 layers of 12.7 mm Type X gypsum board on ceiling side 			
		70 min	68 ^a	37 ^b
NRCC RR-184 FF54	<ul style="list-style-type: none"> 35 mm concrete 0.38 mm thick steel deck with 15.9 mm deep corrugations 203 mm deep steel joist with 1.22 mm material thickness and spaced at 610 mm o.c. 2 layers of 12.7 mm Type X gypsum board on ceiling side 			
		66 min	-	-

Floor/Ceiling – National Research Council of Canada

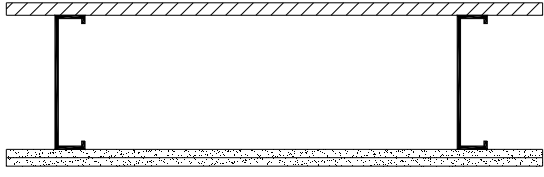
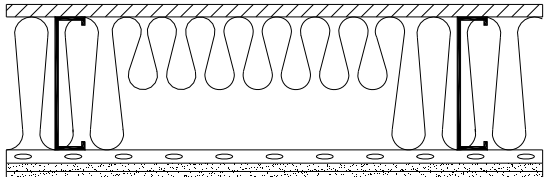
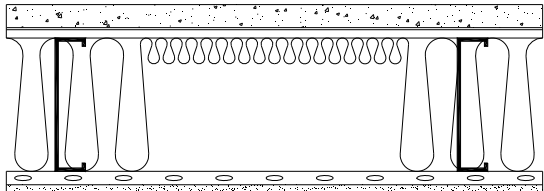
Source	Description	Fire Endurance	Sound Transmission Class	Impact Insulation Class	
NRCC RR-184 FF62	<ul style="list-style-type: none"> subfloor of 19 mm plywood 203 mm deep steel joist with 1.22 mm material thickness and spaced at 610 mm o.c. 2 layers of 12.7 mm Type X gypsum board on ceiling side 		54 min	-	-
NRCC RR-184 FF65 a) TLF-04-011a b) IIF-04-007	<ul style="list-style-type: none"> subfloor of 19 mm plywood 203 mm deep steel joist with 1.22 mm material thickness and spaced at 610 mm o.c. 100 mm thick cellulose fibre insulation on joist sides and 94 mm on underside of subfloor resilient metal channels spaced 610 mm o.c. 2 layers of 12.7 mm Type X gypsum board on ceiling side 		68 min	57 ^a	51 ^b
NRCC RR-184 FF74	<ul style="list-style-type: none"> 35 mm concrete 0.38 mm thick steel deck with 15.9 mm deep corrugations 203 mm deep steel joist with 1.22 mm material thickness and spaced at 610 mm o.c. resilient metal channels spaced 406 mm o.c. 89 mm thick cellulose fibre insulation on joist sides and 38 mm on underside of subfloor 1 layer of 15.9 mm Type X gypsum board on ceiling side 		56 min	63 [*]	29 [*]

* Estimated value as per Warnock (2008)

Floor/Ceiling – Underwriters Laboratories Inc.

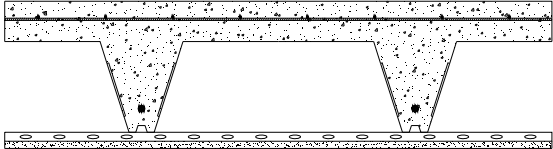
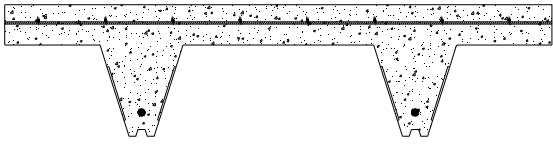
Source	Description	Fire Resistance Rating	Sound Transmission Class	Impact Insulation Class
<p>UL D504</p> <p>NGC Testing Services™</p>	<ul style="list-style-type: none"> min. 3 ⁹/₁₆" concrete topping 6" by 6" W2.9/W2.9 welded wire fabric steel reinforcing bar with 1 ¹⁹/₃₂" concrete cover composite galvanized fluted units, proprietary 8" deep ComSlab® 210 or ComSlab® 225 with min. 20 MSG by Bailey Metal Products Ltd. furring channels spaced 16" o.c. 1 layer of ⁵/₈" gypsum board on ceiling side <p>* for steel deck span > 32' - 9 ⁵/₈"</p> <p>** for steel deck span ≤ 32' - 9 ⁵/₈"</p>		<p>1-¹/₂ h *</p> <p>2 h **</p>	<p>56</p> <p>60 (RFB 6" CER-PAD)</p> <p>60 (CAR-UND)</p> <p>54 (RFB 6" CER-PAD)</p>
<p>UL D930</p>	<ul style="list-style-type: none"> 2 ¹/₂" concrete topping for 1 h, 3 ⁹/₁₆" for 1 ¹/₂ h and 4 ¹/₂" for 2 h 6" by 6" W2.9/W2.9 welded wire fabric steel reinforcing bar with 1 ¹⁹/₃₂" concrete cover composite galvanized fluted units, proprietary 8 ¹/₄" deep COMSLAB® 210 or COMSLAB® 225 with a min. 20 MSG by Bailey Metal Products Ltd. steel deck span ≤ 32' - 9 ⁵/₈" 		<p>1 h</p> <p>1-¹/₂ h</p> <p>2 h</p>	<p>-</p> <p>-</p>

Floor/Ceiling – Underwriters Laboratories Inc.

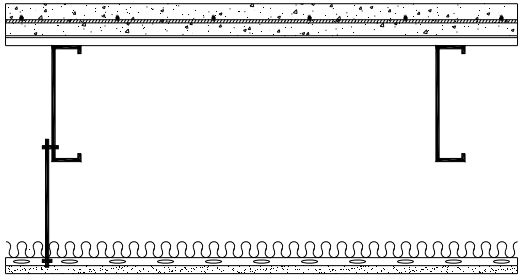
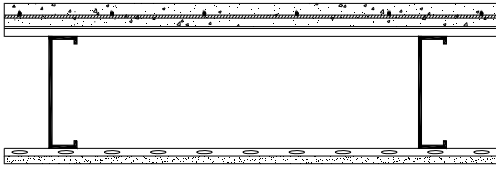
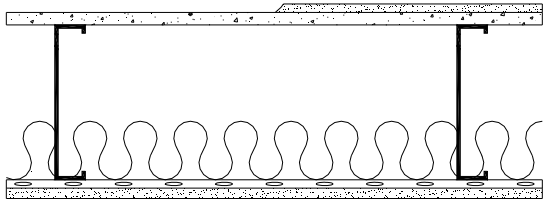
Source	Description	Fire Resistance Rating	Sound Transmission Class	Impact Insulation Class
UL G533 <div style="border: 1px solid black; padding: 2px; display: inline-block;">BXUV7</div>	<ul style="list-style-type: none"> • 2" lightweight concrete with 3400 psi comp. strength • welded wire fabric, 6" by 6", W1.4 x W1.4 • 0.018" thick steel deck with $\frac{19}{32}$" deep corrugations • 7 $\frac{3}{16}$" x 18 MSG steel joist spaced at 24" o.c. • 26 MSG furring channels spaced 24" o.c. • 1" thick mineral wool batts • 1 layer of $\frac{1}{2}$" gypsum board on ceiling side 			
2 h	-	-		
UL G534 <div style="border: 1px solid black; padding: 2px; display: inline-block;">BXUV7</div>	<ul style="list-style-type: none"> • 1½" min. lightweight concrete with 3400 psi comp. strength • welded wire fabric, 6" by 6", 10/10 SWG • 0.018" thick steel deck with $\frac{19}{32}$" deep corrugations • 7 $\frac{3}{16}$" x 18 MSG steel joist spaced at 24" o.c. • 26 MSG furring channels spaced 24" o.c. • 1 layer of $\frac{1}{2}$" gypsum board on ceiling side 			
1 h	-	-		
UL G535	<ul style="list-style-type: none"> • subfloor of $\frac{3}{4}$" thick tongue-and-groove cement-fibre board designated "Fortacrete" • $\frac{1}{2}$" gypsum board or $\frac{3}{4}$" topping mixture on top of subfloor for 2 hour • 9¼" x 16 MSG proprietary steel joist (ClarkDietrich) spaced at 24" o.c. • 3 $\frac{5}{8}$" glass fiber batt insulation • resilient metal channels spaced 12" o.c. • 1 layer of $\frac{5}{8}$" gypsum board on ceiling side 			
1-½ h 2 h	-	-		

Floor/Ceiling – Underwriters Laboratories Inc.

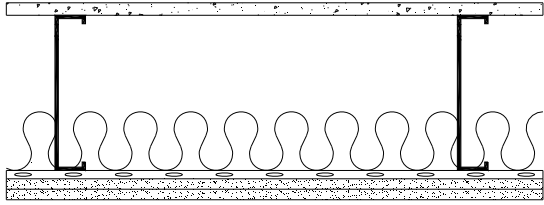
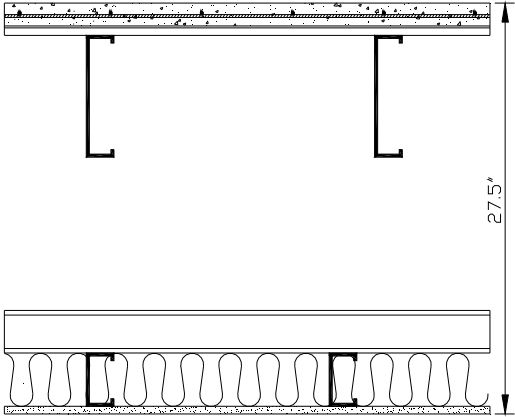
Source	Description	Fire Resistance Rating	Sound Transmission Class	Impact Insulation Class
<p>UL G536</p>	<ul style="list-style-type: none"> • subfloor of 3/4" thick tongue-and-groove cement-fibre board designated "Fortacrete" • 9 1/4" x 16 MSG proprietary steel joist (ClarkDietrich) spaced at 24" o.c. • 3 5/8" glass fiber batt insulation • resilient metal channels spaced 12" o.c. • 2 layers of 5/8" gypsum board on ceiling side 		<p>2 h</p>	<p>-</p>
<p>UL G537</p>	<ul style="list-style-type: none"> • 1 1/2" min. lightweight or normal-weight concrete with 3400 psi and 3500 psi comp. strength, respectively • welded wire fabric, 6" by 6", W1.4 x W1.4 • expanded steel lath with 3/8" rib • 8" x 18 gauge steel joist spaced at 19" o.c. • 3 1/2" x 18 gauge ceiling joists spaced 16" o.c. • insulation optional, 3 1/2" mineral wool loose fill for 1 h and 3 1/2" fiberglass required for 1-1/2 h • 1 layer of 1/2" gypsum board on ceiling side 		<p>1 h 1-1/2 h</p>	<p>-</p>

Floor/Ceiling – Underwriters Laboratories Inc.

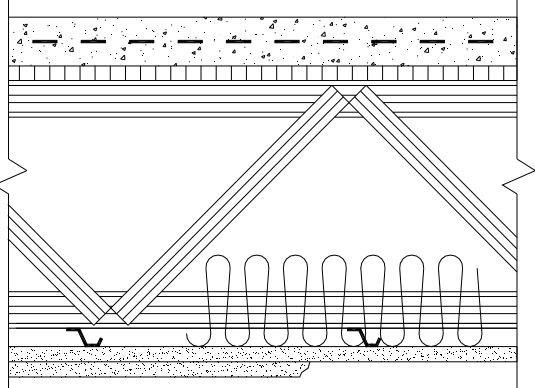
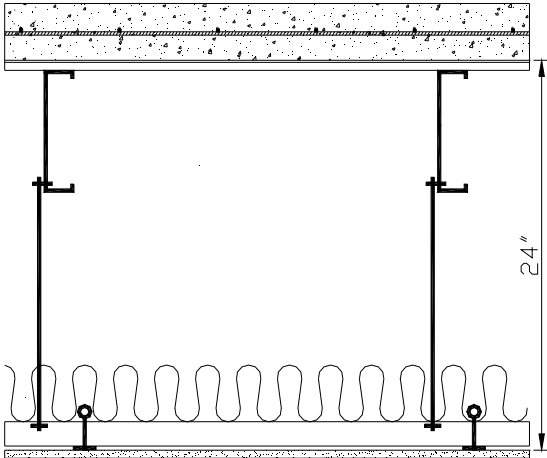
Source	Description	Fire Resistance Rating	Sound Transmission Class	Impact Insulation Class
<p>UL G540</p> <p>BXUV7</p>	<ul style="list-style-type: none"> • 2" min. normal or lightweight concrete with 3000 psi comp. strength • welded wire fabric, 6" by 6", 10/10 SWG • expanded steel lath with 3/8" rib • proprietary pre-fabricated light gauge steel truss system, Ultra-Span by Aegis Metal Framing, spaced at 48" o.c. • resilient or furring channels spaced 16" o.c. • any thickness mineral wool or glass fiber insulation, optional for 1 h and omitted for 2 h • 1 hour - 1 layer of 5/8" gypsum board on ceiling side • 2 hour – 2 layers of 5/8" gypsum board on ceiling side 		<p>1 h</p> <p>2 h</p>	<p>-</p> <p>-</p>
<p>UL G541</p> <p>BXUV7</p>	<ul style="list-style-type: none"> • 3 1/2" min. lightweight concrete with 3400 psi comp. strength • welded wire fabric, 6" by 6", 10/10 SWG • 0.018" thick steel deck with 19/32" deep corrugations • 7 3/16" x 18 MSG steel joist, spaced at 24" o.c. • No. 12 SWG hanger wire spaced 48" o.c. • steel runners, cross tees, cross channels and wall angle framing members • any thickness mineral wool or glass fiber insulation, optional • 1 layer of 1/2" gypsum board on ceiling side 		<p>1 h</p>	<p>-</p> <p>-</p>

Floor/Ceiling – Underwriters Laboratories Inc.

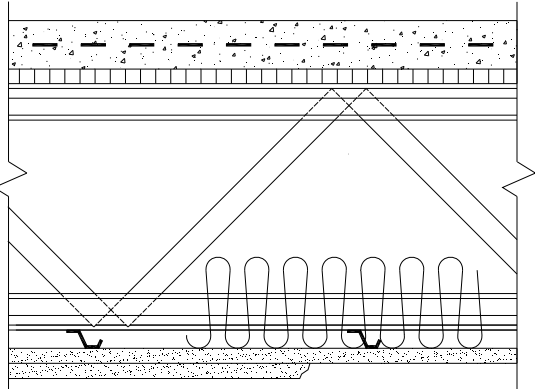
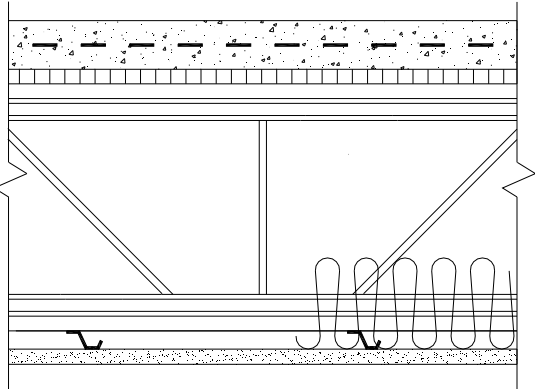
Source	Description	Fire Resistance Rating	Sound Transmission Class	Impact Insulation Class
<p>UL G542</p> <p>BXUV7</p>	<ul style="list-style-type: none"> • 2" min. normal or lightweight concrete with 3000 psi comp. strength • welded wire fabric, 6" by 6", 10/10 SWG • expanded steel lath with 3/8" rib • proprietary pre-fabricated light gauge steel truss system, TrusSteel by Alpine Engineered Products, Inc., spaced at 48" o.c. • resilient or furring channels spaced 16" o.c. • any thickness mineral wool or glass fiber insulation, optional for 1 h and omitted for 2 h • 1 hour - 1 layer of 5/8" gypsum board on ceiling side • 2 hour – 2 layers of 5/8" gypsum board on ceiling side 	 <p>1 h 2 h</p>	-	-
<p>UL G543</p> <p>BXUV7</p>	<ul style="list-style-type: none"> • 2" min. normal or lightweight concrete with 3000 psi comp. strength • welded wire fabric, 6" by 6", 10/10 SWG • expanded steel lath with 3/8" rib • proprietary pre-fabricated light gauge steel truss system, Amkey System by Allied Studco, spaced at 48" o.c. • resilient channels spaced 16" o.c. • any thickness mineral wool or glass fiber insulation, optional • 1 layer of 5/8" gypsum board on ceiling side 	 <p>1 h</p>	-	-

Floor/Ceiling – Underwriters Laboratories Inc.

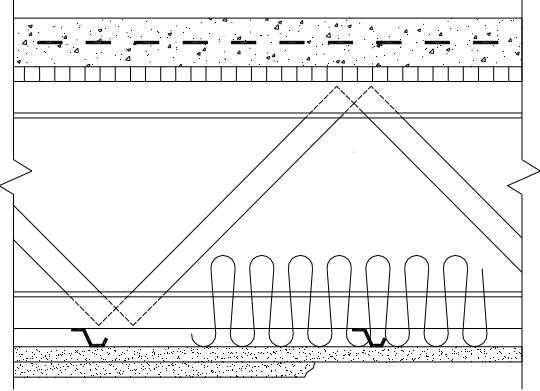
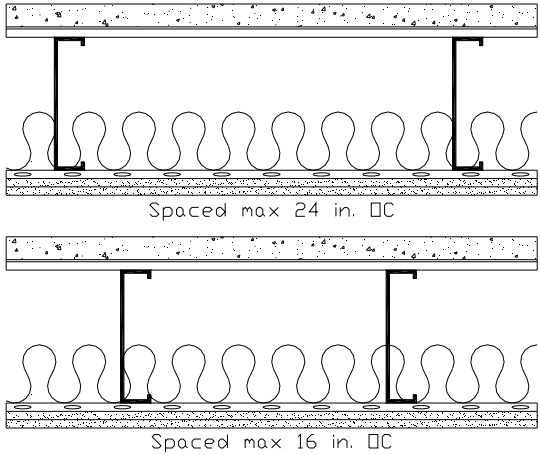
Source	Description	Fire Resistance Rating	Sound Transmission Class	Impact Insulation Class																
<p>UL G546</p> <p>BXUV7</p>	<ul style="list-style-type: none"> • 2" min. normal or lightweight concrete with 3000 psi comp. strength • welded wire fabric, 6" by 6", 10/10 SWG • expanded steel lath with 3/8" rib • proprietary pre-fabricated light gauge steel truss system, Gus Truss by Nucon Steel Corporation, spaced at 48" o.c. • resilient or furring channels spaced 16" o.c. • any thickness mineral wool or glass fiber insulation, optional for 1 h and omitted for 2 h • 1 hour - 1 layer of 5/8" gypsum board on ceiling side • 2 hour – 2 layers of 5/8" gypsum board on ceiling side 																			
<p>UL G549</p> <p>a) TLF-02-051a b) IIF-02-032</p> <p>BXUV7</p>	<ul style="list-style-type: none"> • 1 3/8" concrete • 28 ga (0.015" thick) steel deck with 5/8" deep corrugations • 8" x 18 MSG steel joist spaced at 16" o.c. or 24" o.c. • optional resilient metal channels spaced 24" o.c. • optional 3 1/2" mineral wool or glass fiber batt insulation • 2 layers of 1/2" gypsum board on ceiling side 		<table border="1"> <tr> <td data-bbox="1068 1108 1263 1203" rowspan="2">1 h 2 h</td> <td colspan="2" data-bbox="1263 1108 1312 1203">-</td> </tr> <tr> <td colspan="2" data-bbox="1263 1203 1312 1203">-</td> </tr> </table>	1 h 2 h	-		-		<table border="1"> <tr> <td data-bbox="1312 1108 1472 1203" rowspan="2">1 h</td> <td colspan="2" data-bbox="1312 1203 1472 1245">24" joist spacing</td> </tr> <tr> <td data-bbox="1312 1245 1263 1308">65* (GFB RC) 60* (NI RC)</td> <td data-bbox="1263 1245 1472 1308">29* (GFB RC) 30* (NI RC)</td> </tr> <tr> <td data-bbox="1312 1308 1472 1350"></td> <td colspan="2" data-bbox="1312 1350 1472 1392">16" joist spacing</td> </tr> <tr> <td data-bbox="1312 1392 1263 1455">66^a (GFB RC) 60* (NI RC)</td> <td colspan="2" data-bbox="1263 1392 1472 1455">34^b (GFB RC) <30* (NI RC)</td> </tr> </table>	1 h	24" joist spacing		65* (GFB RC) 60* (NI RC)	29* (GFB RC) 30* (NI RC)		16" joist spacing		66 ^a (GFB RC) 60* (NI RC)	34 ^b (GFB RC) <30* (NI RC)	
1 h 2 h	-																			
	-																			
1 h	24" joist spacing																			
	65* (GFB RC) 60* (NI RC)	29* (GFB RC) 30* (NI RC)																		
	16" joist spacing																			
66 ^a (GFB RC) 60* (NI RC)	34 ^b (GFB RC) <30* (NI RC)																			

* Estimated value as per Warnock (2008)

Floor/Ceiling – Underwriters Laboratories Inc.

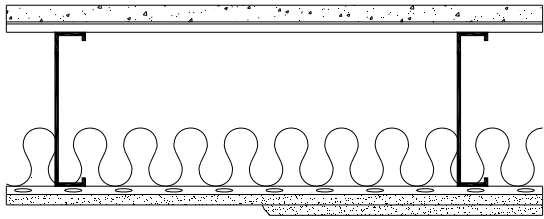
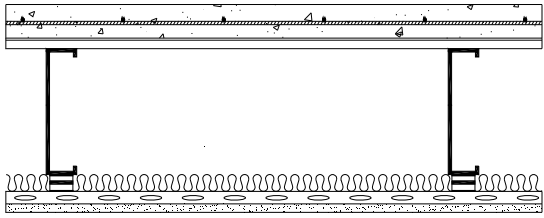
Source	Description	Fire Resistance Rating	Sound Transmission Class	Impact Insulation Class
<p>UL G551</p> <p>BXUV7</p>	<ul style="list-style-type: none"> • 1" min. floor topping mixture with 3500 psi comp. strength • 9/16" min. deep, 22 MSG corrugated fluted steel deck • 9 1/4" x 16 MSG proprietary steel joist (ClarkDietrich) spaced at 24" o.c. • resilient metal channels spaced 12" o.c. • 3 1/2" mineral wool or glass fiber batt insulation • 1 hour - 1 layer of 5/8" gypsum board on ceiling side • 2 hour – 2 layers of 5/8" gypsum board on ceiling side 		<p>1 h</p> <p>2 h</p>	<p>-</p> <p>-</p>
<p>UL G552</p> <p>BXUV7</p>	<ul style="list-style-type: none"> • 2" min. lightweight concrete with 3400 psi comp. Strength • welded wire fabric, 6" x 6" – W1.4 x W1.4 • 0.018" thick steel deck with 19/32" deep corrugations • 7 3/16" x 18 MSG steel joist, spaced at 24" o.c. • furring channels spaced 24" o.c. • 1" mineral wool batt insulation • 1 layer of 1/2" gypsum board on ceiling side 		<p>2 h</p>	<p>-</p> <p>-</p>

Floor/Ceiling – Underwriters Laboratories Inc.

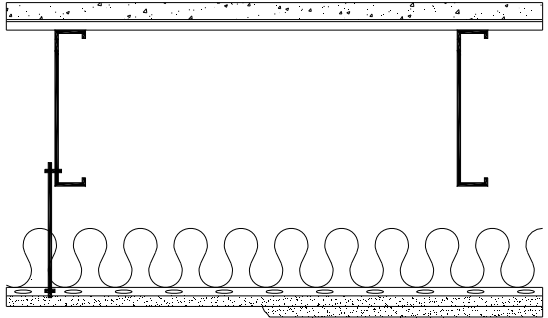
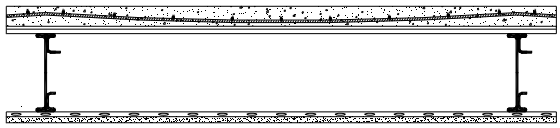
Source	Description	Fire Resistance Rating	Sound Transmission Class	Impact Insulation Class
UL G553 BXUV7	<ul style="list-style-type: none"> • 1" min. floor topping mixture with 3500 psi comp. strength • $\frac{9}{16}$" min. deep, 22 MSG corrugated fluted steel deck • $9\frac{1}{4}$" x 16 MSG proprietary steel joist (ClarkDietrich) spaced at 24" o.c. • hanger wire 12 SWG at 48" o.c. • resilient metal channels spaced 12" o.c. • 3 $\frac{1}{2}$" mineral wool or glass fiber batt insulation • 1 hour - 1 layer of $\frac{5}{8}$" gypsum board on ceiling side • 2 hour – 2 layers of $\frac{5}{8}$" gypsum board on ceiling side 			
UL G555	<ul style="list-style-type: none"> • 2 $\frac{3}{16}$" concrete slab with 6" by 6" W2.9 x W2.9 welded wire fabric on 22 MSG thick steel deck with $\frac{9}{16}$" deep corrugations • 8" deep, min. 16 ga. thick proprietary composite steel joist, TotalJoist™ by iSPAN Systems LP spaced at 48" o.c. • resilient channels spaced 24" o.c. • 1 layer of $\frac{5}{8}$" gypsum board on ceiling side 		1 h 2 h	- -
		1 h 2 h	50 to 56	25 to 68

Floor/Ceiling – Underwriters Laboratories Inc.

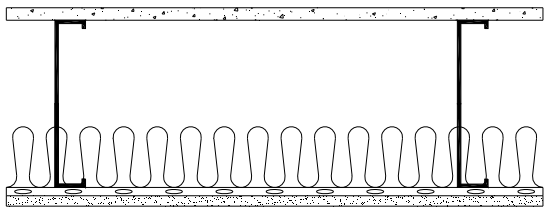
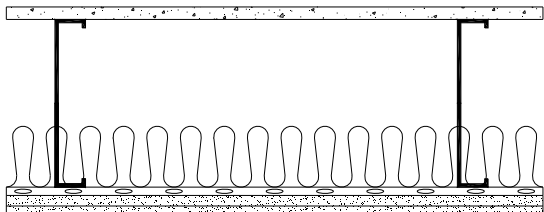
Source	Description	Fire Resistance Rating	Sound Transmission Class	Impact Insulation Class
UL G556	<ul style="list-style-type: none"> • subfloor of ¾" thick tongue-and-groove cement-fibre board designated "Fortacrete" • ½" gypsum board or ¾" topping mixture on top of subfloor for 2 h • 10" x 16 MSG steel joist for 1-½ h and 6" x 18 MSG or 8" x 16 MSG for 1 h, spaced at 24" o.c. • 3 ⅝" glass fiber batt insulation • resilient metal channels spaced 12" o.c. • 1 layer of ⅝" gypsum board on ceiling side 			
		1 h 1-½ h 2 h	-	-
UL G557	<ul style="list-style-type: none"> • subfloor of ¾" thick tongue-and-groove cement-fibre board designated "Fortacrete" • 10" x 16 MSG, 6" x 18 MSG or 8" x 16 MSG steel joist spaced at 24" o.c. • 3 ⅝" glass fiber batt insulation • resilient metal channels spaced 12" o.c. • 2 layers of ⅝" gypsum board on ceiling side 			
		2 h	-	-

Floor/Ceiling – Underwriters Laboratories Inc.

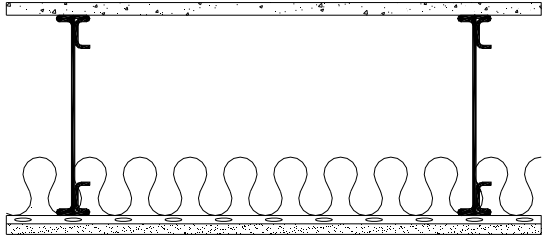
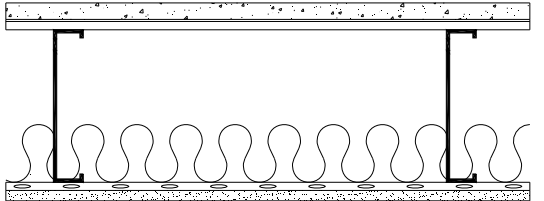
Source	Description	Fire Resistance Rating	Sound Transmission Class	Impact Insulation Class
UL G558	<ul style="list-style-type: none"> • subfloor of ¾" thick tongue-and-groove cement-fibre board designated "Type USG Fortacrete" • 12" deep proprietary steel joist, TotalJoist™ by iSPAN Systems LP with 18 ga material thickness and spaced at 24" o.c. • resilient metal channels spaced 12" o.c. • 3½" glass fiber batt insulation • 1 layer of 5/8" gypsum board on ceiling side 			
		1 h	56 to 64*	-
UL G559 BXUV7	<ul style="list-style-type: none"> • 1" min. floor topping mixture with 3500 psi comp. strength • 9/16" min. deep, 22 MSG corrugated fluted steel deck • 9¼" x 16 MSG proprietary steel joist (CEMCO) spaced at 24" o.c. • resilient metal channels spaced 12" o.c. • 3 ½" glass fiber batt insulation • 1 layer of 5/8" gypsum board on ceiling side 			
		2 h	-	-

* Brunette, N.L., Airborne Sound Transmission Loss and Impact Sound Transmission Measurements Performed on One Floor Assembly, NRC Client Report B-3454.1, National Research Council of Canada, Ottawa, Ontario, Canada, 2007.

Floor/Ceiling – Underwriters Laboratories Inc.

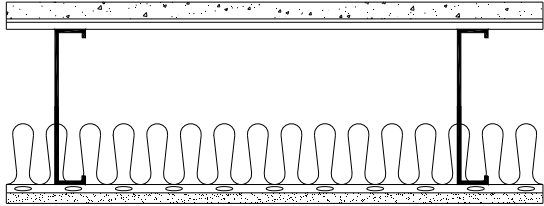
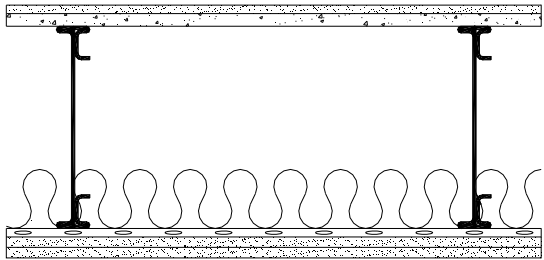
Source	Description	Fire Resistance Rating	Sound Transmission Class	Impact Insulation Class	
UL G560 BXUV7	<ul style="list-style-type: none"> 1" min. floor topping mixture with 3500 psi comp. strength $\frac{9}{16}$" min. deep, 22 MSG corrugated fluted steel deck $9\frac{1}{4}$" deep steel joist with 0.055" material thickness and spaced at 24" o.c. resilient metal channels spaced 12" o.c. $3\frac{1}{2}$" mineral wool or glass fiber batt insulation 1 layer of $\frac{5}{8}$" gypsum board on ceiling side 		2 h	-	-
UL G562	<ul style="list-style-type: none"> subfloor of $\frac{3}{4}$" thick tongue-and-groove cement-fibre board designated "Type Structo-Crete" topped with $\frac{1}{2}$" thick gypsum board (System A) or $\frac{3}{4}$" thick floor topping mixture (System B) 12" deep proprietary steel joist, TotalJoist™ by iSPAN Systems LP with 18 ga material thickness and spaced at 24" o.c. resilient metal channels spaced 12" o.c. $3\frac{1}{2}$" glass fiber batt insulation 2 layers of $\frac{5}{8}$" gypsum board on ceiling side 		2 h	61*	-

* Brunette, N.L., Airborne Sound Transmission Loss and Impact Sound Transmission Measurements Performed on One Floor Assembly, NRC Client Report B-3454.6, National Research Council of Canada, Ottawa, Ontario, Canada, 2007.

Floor/Ceiling – Underwriters Laboratories Inc.

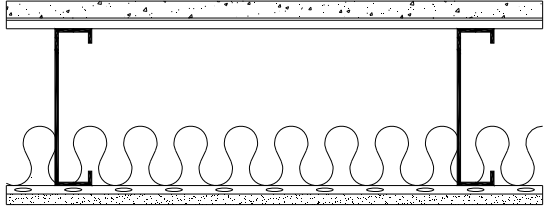
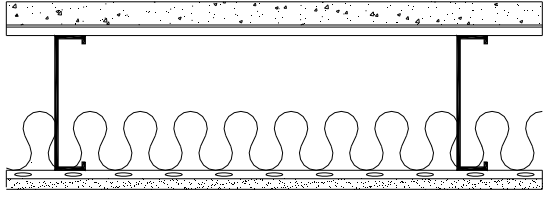
Source	Description	Fire Resistance Rating	Sound Transmission Class	Impact Insulation Class
UL G563 BXUV7	<ul style="list-style-type: none"> • 1" min. floor topping mixture with 3500 psi comp. strength • 9/16" min. deep, 22 MSG corrugated fluted steel deck • 9¼" x 16 MSG proprietary steel joist (Marino\WARE) spaced at 24" o.c. • resilient metal channels spaced at 12" o.c. • 3½" glass fiber batt insulation • 1 layer of 5/8" gypsum board on ceiling side 			
		2 h	-	-
UL G564 BXUV7	<ul style="list-style-type: none"> • 1⅝" min. floor topping mixture with 3500 psi comp. strength • 9/16" min. deep, 22 MSG corrugated fluted steel deck • 8" x 16 MSG steel joist spaced at 24" o.c. • resilient metal channels spaced at 12" o.c. • 3½" mineral wool or glass fiber insulation • 1 layer of 5/8" gypsum board on ceiling side 			
		1 h 2 h	-	-

Floor/Ceiling – Underwriters Laboratories Inc.

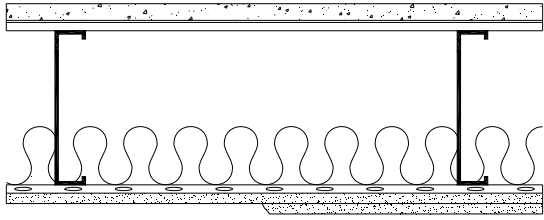
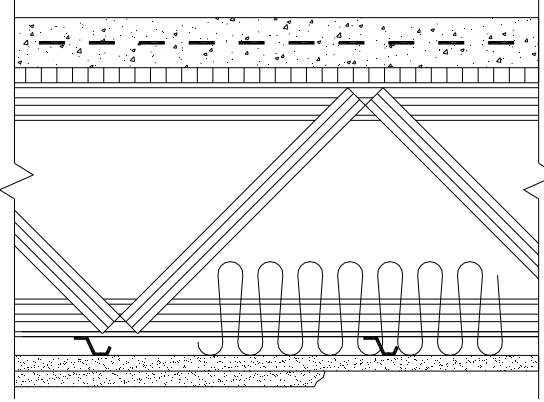
Source	Description	Fire Resistance Rating	Sound Transmission Class	Impact Insulation Class
<p>UL G565</p> <p>BXUV7</p>	<ul style="list-style-type: none"> • 1" min. floor topping mixture with 3500 psi comp. strength • 9/16" min. deep, 22 MSG corrugated fluted steel deck • 9¼" x 16 MSG steel joist spaced at 24" o.c. • resilient channels spaced 12" o.c. • 3 ½" mineral wool or glass fiber insulation • 1 and 1½ hour - 1 layer of 5/8" gypsum board on ceiling side • 2 hour - 2 layers of 5/8" gypsum board on ceiling side 			
<p>1 h</p> <p>1½ h</p> <p>2 h</p>	<p>-</p>	<p>-</p>		
<p>UL G567</p> <p>BXUV7</p>	<ul style="list-style-type: none"> • 2" min. normal or lightweight concrete with 3000 psi comp. strength • welded wire fabric, 6" by 6", 10/10 SWG • expanded steel lath with 3/8" rib • trusses spaced a max, 48" o.c. • proprietary pre-fabricated light gauge steel truss systems, <ol style="list-style-type: none"> 1. Ultra-Span by Aegis Metal Framing 2. Amkey System by Allied Studco 3. NUTRUSS/NUTRUSS 3.0 by Nucon Steel Corporation • resilient or furring channels spaced 16" o.c. • any thickness mineral wool or glass fiber insulation, optional for 1 h and omitted for 2 h • 1 hour - 1 layer of 5/8" gypsum board on ceiling side • 2 hour – 2 layers of 5/8" gypsum board on ceiling side 			
<p>1 h</p> <p>2 h</p>	<p>-</p>	<p>-</p>		

Floor/Ceiling – Underwriters Laboratories Inc.

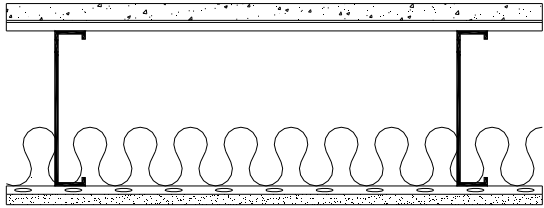
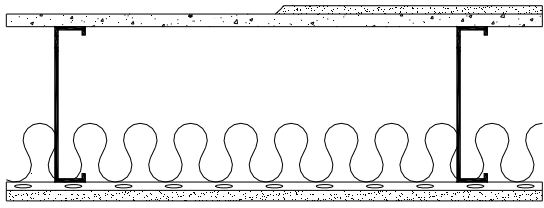
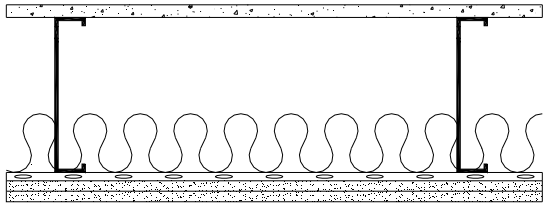
Source	Description	Fire Resistance Rating	Sound Transmission Class	Impact Insulation Class
UL G568 BXUV7	<ul style="list-style-type: none"> • 1" min. floor topping mixture with 3500 psi comp. strength • 9/16" min. deep, 22 MSG corrugated fluted steel deck • 9¼" x 16 MSG steel joist spaced at 24" o.c. • resilient metal channels spaced at 12" o.c. • 3½" mineral wool or glass fiber insulation • 1 layer of 5/8" gypsum board on ceiling side 			
1 h	-			
UL G569	<ul style="list-style-type: none"> • subfloor of ¾" thick tongue-and-groove cement-fibre board designated "Structo-Crete" • ½" gypsum board or ¾" topping mixture on top of subfloor for 2 hour • 9¼" x 16 MSG proprietary steel joist (Nucon Steel Corp.) spaced at 24" o.c. • 3 5/8" glass fiber batt insulation • resilient metal channels spaced 12" o.c. • 1 layer of 5/8" gypsum board on ceiling side 			
1½ h 2 h	-			
UL G570	<ul style="list-style-type: none"> • subfloor of ¾" thick tongue-and-groove cement-fibre board designated "Structo-Crete" • 9¼" x 16 MSG proprietary steel joist (Nucon Steel Corp.) spaced at 24" o.c. • 3 5/8" glass fiber batt insulation • resilient metal channels spaced 12" o.c. • 2 layers of 5/8" gypsum board on ceiling side 			
2 h	-			

Floor/Ceiling – Underwriters Laboratories Inc.

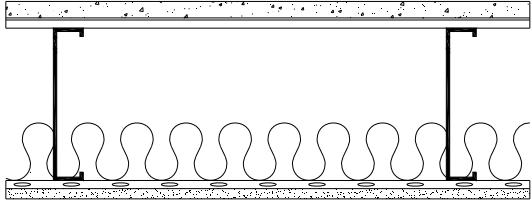
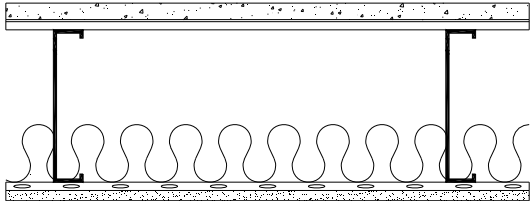
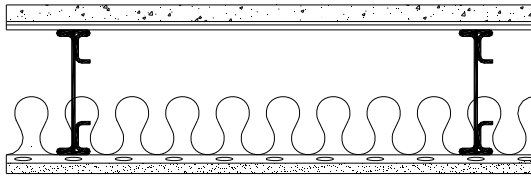
Source	Description	Fire Resistance Rating	Sound Transmission Class	Impact Insulation Class
UL G571 BXUV7	<ul style="list-style-type: none"> 1" min. floor topping mixture with 3500 psi comp. strength $\frac{9}{16}$" min. deep, 22 MSG corrugated fluted steel deck $9\frac{1}{4}$" x 16 MSG proprietary steel joist (Nucon Steel Corp.) spaced at 24" o.c. resilient metal channels spaced 12" o.c. 3 $\frac{1}{2}$" mineral wool or glass fiber batt insulation 1 layer of $\frac{5}{8}$" gypsum board on ceiling side 			
		2 h	-	-
UL G574 BXUV7	<ul style="list-style-type: none"> 1" min. floor topping mixture with 3500 psi comp. strength $\frac{9}{16}$" min. deep, 22 MSG corrugated fluted steel deck $9\frac{1}{4}$" x 16 MSG proprietary steel joist (CEMCO) spaced at 24" o.c. resilient metal channels spaced 12" o.c. 3 $\frac{1}{2}$" glass fiber batt insulation 1 layer of $\frac{5}{8}$" gypsum board on ceiling side 			
		2 h	-	-
UL G587	<ul style="list-style-type: none"> min. 1" floor topping mixture $\frac{9}{16}$" min. deep, 20 MSG corrugated fluted steel deck $7\frac{1}{2}$" x 20 GA proprietary steel joist, TotalJoist™ by iSPAN Systems LP spaced at 24" o.c. resilient metal channels spaced 12" o.c. 3 $\frac{1}{2}$" glass fibre insulation 1 layer of $\frac{5}{8}$" gypsum board on ceiling side 			
		1½ h 2 h	59 to 62*	41 to 65*

* STC and IIC ratings based on 10" deep joists and deeper. A range of STC and IIC ratings available depending on system type and finished floor type, contact iSPAN Systems LP for more information.

Floor/Ceiling – Underwriters Laboratories Inc.

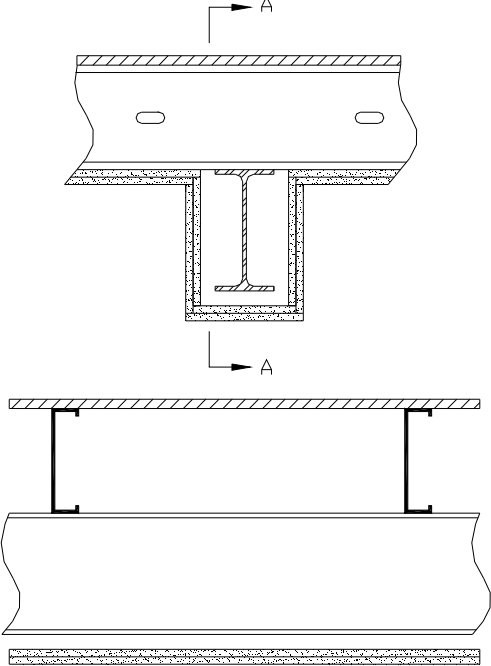
Source	Description	Fire Resistance Rating	Sound Transmission Class	Impact Insulation Class
<p>UL G589</p>	<ul style="list-style-type: none"> • 2 ³/₁₆" concrete slab with 6" x 6" W2.9 x W2.9 welded wire fabric on 22 MSG steel deck with ⁹/₁₆" deep corrugations • 8" deep, min. 16 ga. thick proprietary composite steel joist, TotalJoist™ by iSPAN Systems LP spaced at 48" o.c. • resilient channels spaced 24" o.c. • 1 layer of ⁵/₈" gypsum board on ceiling side 			
		<p>1 h 2 h 3 h</p>	<p>50 to 56</p>	<p>25 to 68</p>
<p>UL L524</p> <p>a) USG760105 b) USG760310 c) USG760106 d) USG760405</p> <p>BXUV7</p>	<p>Steel Beam – W8x15 min. size</p> <ul style="list-style-type: none"> • subfloor of ¹⁹/₃₂" plywood • 7" x 18 MSG steel joist spaced at 24" o.c. • 2 layers of ¹/₂" gypsum board on ceiling side <p>a) Based on 9½" 16 gauge steel joists b) Based on 9½" 16 gauge steel joists and 3" mineral wool batt c) Based on 9½" 16 gauge steel joists and carpet pad d) Based on 9½" 16 gauge steel joists and carpet pad with 3" mineral wool batt</p>	 <p style="text-align: center;">Section A-A</p>		
		<p>1 h</p>	<p>39^a 43^b 56^c 60^d</p>	<p>-</p>

Floor/Ceiling – Underwriters Laboratories Inc.

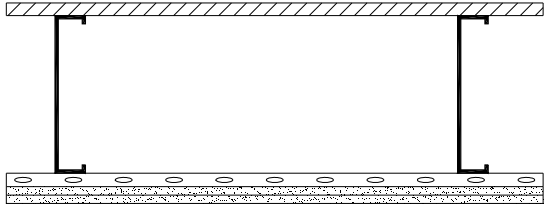
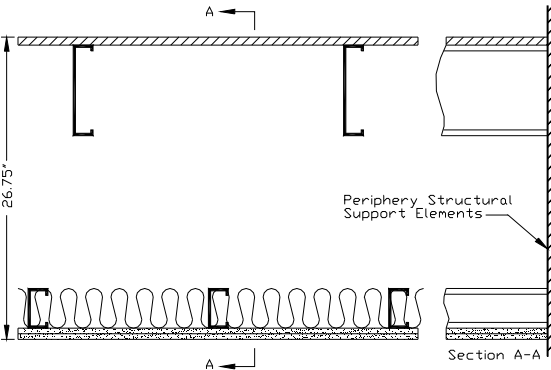
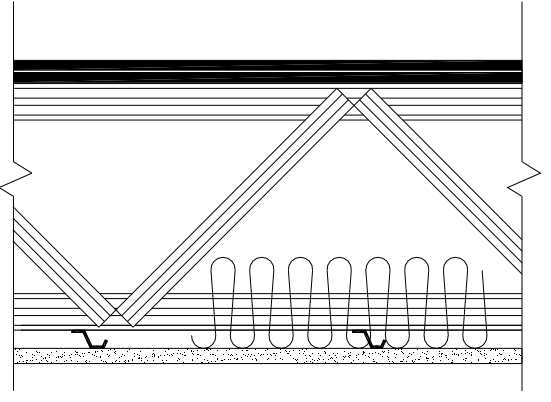
Source	Description	Fire Resistance Rating	Sound Transmission Class	Impact Insulation Class	
UL L527 a) USG771101 b) SA781110 BXUV7	<ul style="list-style-type: none"> subfloor of 3/4" plywood 9 3/8" x 16 MSG steel joist spaced at 24" o.c. 24 ga metal resilient channels spaced 16" o.c. 2 layers of 5/8" gypsum board on ceiling side 		1-1/2 h	48 ^a 51 ^b (CAR-UND)	<40* 70* (CAR-UND)
UL L543 BXUV7	<ul style="list-style-type: none"> subfloor of 23/32" plywood 8" x 18 MSG steel joist spaced at 19" o.c. 3 1/2" x 18 MSG ceiling steel joists spaced at 16" o.c. 3 1/2" mineral wool insulation 2 layers of 1/2" gypsum board on ceiling side 		1 h	> 60*	> 50*
UL L549 BXUV7	<ul style="list-style-type: none"> 2 layer flooring system (9 types) proprietary pre-fabricated light gauge steel truss system, Ultra-Span by Aegis Metal Framing, spaced at 48" o.c. resilient or furring channels spaced 16" o.c. any thickness mineral wool or glass fiber insulation, optional 1 layer of 5/8" gypsum board on ceiling side 		1 h	-	-

* Estimated value as per Warnock (2008)

Floor/Ceiling – Underwriters Laboratories Inc.

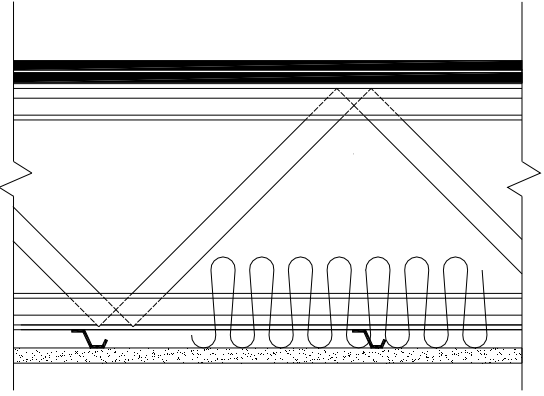
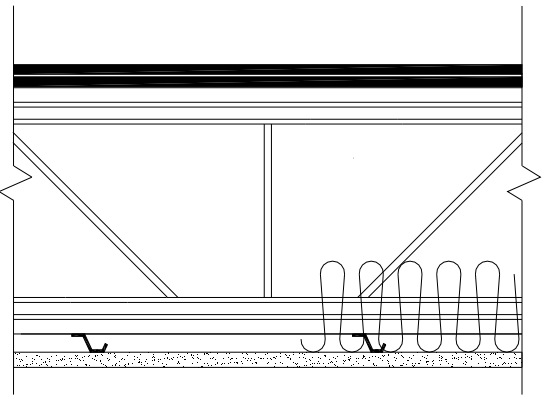
Source	Description	Fire Resistance Rating	Sound Transmission Class	Impact Insulation Class
<p>UL L551</p> <p>BXUV7</p>	<ul style="list-style-type: none"> • 2 layer flooring system (9 types) • proprietary pre-fabricated light gauge steel truss system, TrusSteel by Alpine Engineered Products, Inc., spaced at 48" o.c. • resilient or furring channels spaced 16" o.c. • any thickness mineral wool or glass fiber insulation, optional • 1 layer of 5/8" gypsum board on ceiling side 		<p>1 h</p>	<p>-</p>
<p>UL L552</p> <p>BXUV7</p>	<ul style="list-style-type: none"> • 2 layer flooring system (9 types) • proprietary pre-fabricated light gauge steel truss system, Amkey System by Allied Studco, spaced at 48" o.c. • resilient channels spaced 16" o.c. • any thickness mineral wool or glass fiber insulation, optional • 1 layer of 5/8" gypsum board on ceiling side 		<p>1 h</p>	<p>-</p>

Floor/Ceiling – Underwriters Laboratories Inc.

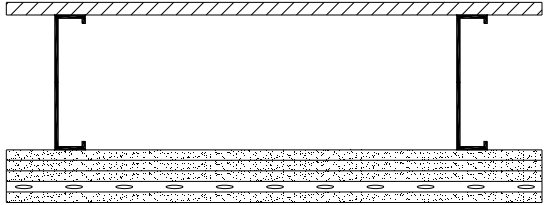
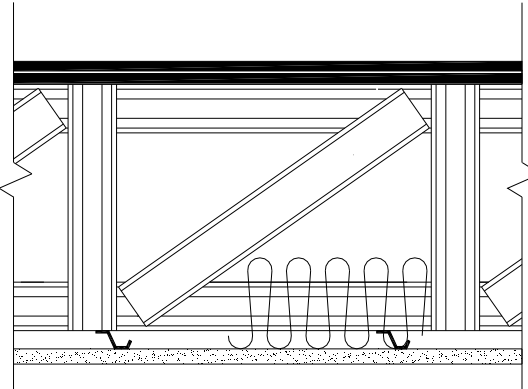
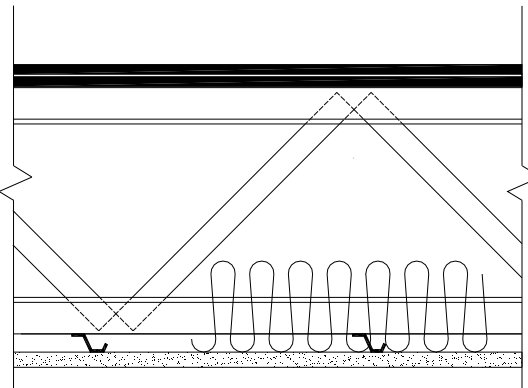
Source	Description	Fire Resistance Rating	Sound Transmission Class	Impact Insulation Class			
<p>UL L556</p> <p>a) NGC5004021 b) NGC7004068 c) NGC7004069</p> <p>BXUV7</p>	<ul style="list-style-type: none"> • subfloor of 3/4" plywood • 8" x 18 MSG steel joist spaced at 24" o.c. • 4 layers of 5/8" Type X gypsum board on ceiling side • resilient metal channels spaced 24" o.c. and applied perpendicular to joists over third layer of gypsum board 				2 h	48 ^a	37 ^b 60 ^c (CAR-UND)
<p>UL L559</p> <p>BXUV7</p>	<ul style="list-style-type: none"> • 2 layer flooring system (9 types) • proprietary pre-fabricated light gauge steel truss system, Strong-Span by Hexaport International Ltd., spaced at 48" o.c. • resilient or furring channels spaced 16" o.c. • any thickness mineral wool or glass fiber insulation, optional • 1 layer of 5/8" gypsum board on ceiling side 				1 h	-	-
<p>UL L560</p> <p>BXUV7</p>	<ul style="list-style-type: none"> • 2 layer flooring system (9 types) • proprietary pre-fabricated light gauge steel truss system, Gus Truss by Nucon Steel Corporation, spaced at 48" o.c. • resilient or furring channels spaced 16" o.c. • any thickness mineral wool or glass fiber insulation, optional • 1 layer of 5/8" gypsum board on ceiling side 				1 h	-	-

Floor/Ceiling – Underwriters Laboratories Inc.

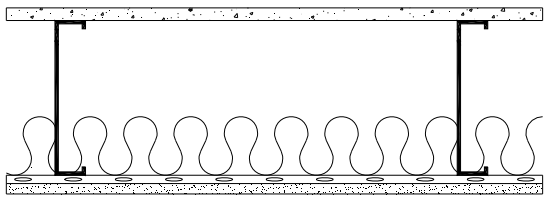
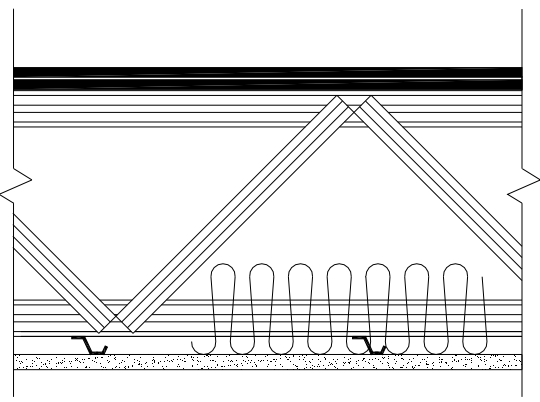
Source	Description	Fire Resistance Rating	Sound Transmission Class	Impact Insulation Class
<p>UL L564</p> <p>BXUV7</p>	<ul style="list-style-type: none"> • subfloor of 3/4" cement-fiber unit • 9 1/4" x 16 MSG proprietary steel joist (ClarkDietrich) spaced at 24" o.c. • resilient metal channels spaced 12" o.c. • 3 5/8" mineral wool or glass fiber batt insulation • 1 layer of 5/8" gypsum board on ceiling side 			
<p>UL L565</p> <p>BXUV7</p>	<ul style="list-style-type: none"> • 2 layer flooring system (6 types) • trusses spaced a max. 48" o.c. • proprietary pre-fabricated light gauge steel truss systems, <ol style="list-style-type: none"> 1. Ultra-Span by Aegis Metal Framing 2. Amkey System by Allied Studco 3. Versa-Truss by Dale/Incor 4. Truss by Steel Construction Systems Inc. 5. NUTRUSS/NUTRUSS 3.0 by Nucon Steel Corporation 6. TrusSteel by TrusSteel, Division of ITW Building Components Inc. • resilient or furring channels spaced 16" o.c. • any thickness mineral wool or glass fiber insulation, optional • 1 layer of 5/8" gypsum board on ceiling side 			
		1 h	-	-

Floor/Ceiling – Underwriters Laboratories Inc.

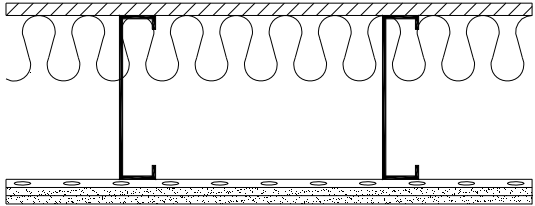
Source	Description	Fire Resistance Rating	Sound Transmission Class	Impact Insulation Class
UL L567 BXUV7	<ul style="list-style-type: none"> • subfloor of 3/4" plywood • 10" x 16 MSG proprietary "Type JR JoistRite" steel joist (Marino\WARE) spaced at 16" o.c. • resilient metal channels spaced 16" o.c. • 4" mineral wool or glass fiber insulation friction-fit to underside of plywood • 2 layers of 1/2" gypsum board on ceiling side <p>* 77% load restriction</p>		-	-
* 1 h				

Floor/Ceiling – Underwriters Laboratories Inc.

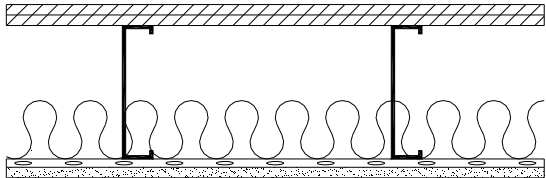
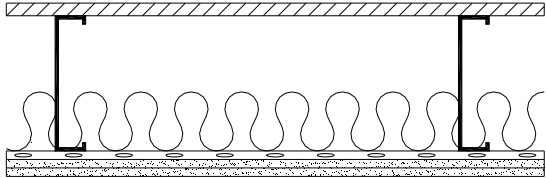
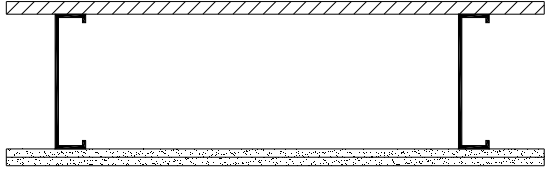
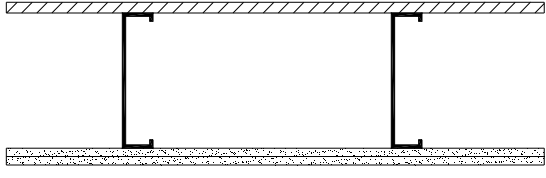
Source	Description	Fire Resistance Rating	Sound Transmission Class	Impact Insulation Class	
UL L568 BXUV7	<ul style="list-style-type: none"> • subfloor of 5/8" plywood and finish floor of 5/8" wood structural panels • 8" x 18 MSG steel joist spaced at 16" o.c. • resilient metal channels spaced 16" o.c. • 3 1/2" mineral wool batt insulation • 1 layer of 5/8" gypsum board on ceiling side 		45 min	53*	46*
	<ul style="list-style-type: none"> • subfloor of 3/4" plywood • 8" x 18 MSG steel joist spaced at 24" o.c. • resilient metal channels spaced 24" o.c. • 3 1/2" glass fiber batt insulation • 2 layers of 1/2" gypsum board on ceiling side 		45 min	52*	45*
	<ul style="list-style-type: none"> • subfloor of 3/4" plywood • 8" x 18 MSG steel joist spaced at 24" o.c. • 2 layers of 1/2" gypsum board on ceiling side 		45 min	<40*	<40*
	<ul style="list-style-type: none"> • subfloor of 5/8" plywood • 8" x 18 MSG steel joist spaced at 16" o.c. • 2 layers of 1/2" gypsum board on ceiling side 		1 h	<40*	<40*

* Estimated value as per Warnock (2008)

Floor/Ceiling – Underwriters Laboratories Inc.

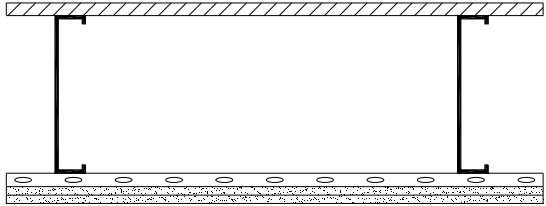
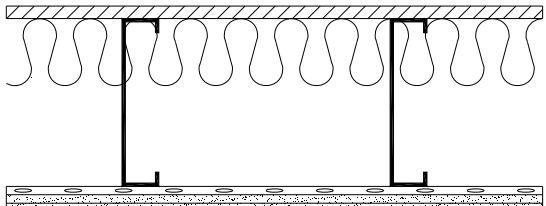
Source	Description	Fire Resistance Rating	Sound Transmission Class	Impact Insulation Class
UL L573 BXUV7	<ul style="list-style-type: none"> • subfloor of 3/4" plywood • 9 3/8" x 16 MSG steel joist spaced at 24" o.c. • furring channels spaced 16" o.c. • 2 layers of 5/8" gypsum board on ceiling side 			
		1 h	-	-
UL L580	<ul style="list-style-type: none"> • subfloor of 3/4" plywood • 10" x 16 MSG proprietary steel joist (Marino\WARE) spaced at 16" o.c. • resilient metal channels spaced 16" o.c. • 4" mineral wool insulation friction-fit to underside of plywood • 2 layers of 1/2" gypsum board on ceiling side <p>* 70% load restriction</p>			
		* 1 h	-	-

Floor/Ceiling – Underwriters Laboratories Inc.

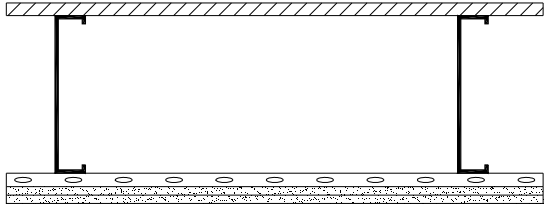
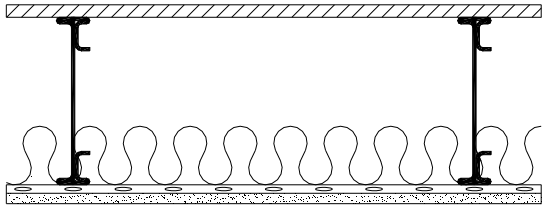
Source	Description	Fire Resistance Rating	Sound Transmission Class	Impact Insulation Class
UL L599 BXUV7	<ul style="list-style-type: none"> subfloor of $\frac{3}{4}$" plywood 9 $\frac{1}{4}$" x 16 MSG steel joist spaced at 24" o.c. resilient channels spaced 16" o.c. 2 layers of $\frac{5}{8}$" gypsum board on ceiling side 			
		1½ h	-	-
UL M511	<ul style="list-style-type: none"> subfloor of $\frac{3}{4}$" plywood or OSB with optional min. $\frac{3}{4}$" floor topping mixture (System A). In lieu of plywood or OSB subfloor, $\frac{7}{8}$" min. deep, 22 GA corrugated steel deck with min. $1\frac{7}{8}$" normal weight concrete (System C) min. 10" deep proprietary steel joist, TotalJoist™ by iSPAN Systems LP with 18 GA material thickness and spaced at 24" o.c. resilient metal channels spaced 12" o.c. 3" mineral wool batt insulation 1 layer of $\frac{5}{8}$" gypsum board on ceiling side 			
		1 h	50 to 63*	38 to 72*

* STC and IIC ratings based on 10" deep joists and deeper. A range of STC and IIC ratings available depending on system type and finished floor type, contact iSPAN Systems LP for more information.

Floor/Ceiling – Underwriters Laboratories Inc.

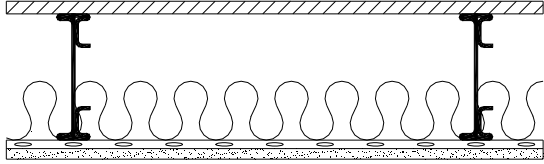
Source	Description	Fire Resistance Rating	Sound Transmission Class	Impact Insulation Class
UL M515	<ul style="list-style-type: none"> • subfloor of ¾" plywood, OSB or structural cement-fiber units designated "Armoroc Panel" with optional min. ¾" floor topping mixture • min. 7.5" deep proprietary steel joist, TotalJoist™ by iSPAN Systems LP with 20 GA material thickness and spaced at 24" o.c. • resilient metal channels spaced 12" o.c. • 3½" thick glass fibre batt insulation • 1 layer of 5⁄8" gypsum board on ceiling side 			
		1 h	50*	43*

* STC and IIC ratings based on 10" deep joists and deeper. A range of STC and IIC ratings available depending on system type and finished floor type, contact iSPAN Systems LP for more information.

Floor/Ceiling – Gypsum Association

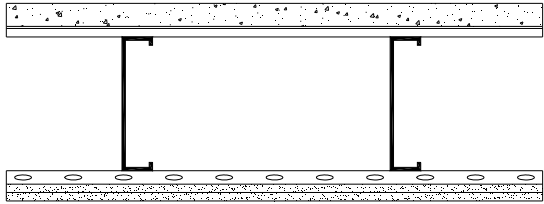
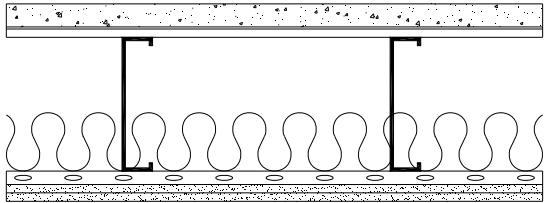
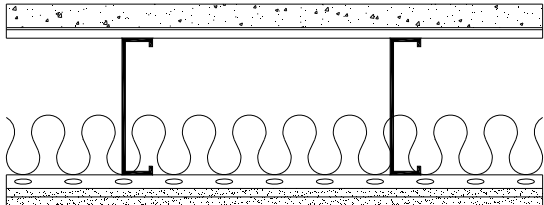
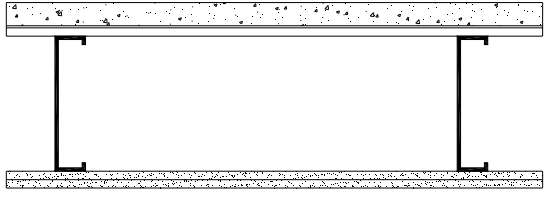
Source	Description	Fire Resistance Rating	Sound Transmission Class	Impact Insulation Class	
GA FC 1141	<ul style="list-style-type: none"> • 1$\frac{3}{8}$" concrete • 30 gage steel deck with $\frac{5}{8}$" deep corrugations • 8" x 18 gage steel joist spaced at 16" o.c. • resilient furring channels spaced 16" o.c. • 2 layers of $\frac{1}{2}$" Type X gypsum board on ceiling side 		1 h	-	-
GA FC 1142	<ul style="list-style-type: none"> • 1$\frac{3}{8}$" concrete • 30 gage steel deck with $\frac{5}{8}$" deep corrugations • 8" x 18 gage steel spaced at 16" o.c. • resilient furring channels spaced 16" o.c. • 3$\frac{1}{2}$" thick glass fiber insulation • 2 layers of $\frac{1}{2}$" Type X gypsum board on ceiling side 		1 h	-	-
GA FC 1143	<ul style="list-style-type: none"> • 1$\frac{3}{8}$" concrete • 30 gage steel deck with $\frac{5}{8}$" deep corrugations • 8 x 18 gage steel spaced at 16" o.c. • resilient furring channels spaced 16" o.c. • 3$\frac{1}{2}$" thick glass fiber or rock fiber insulation • 2 layers of $\frac{1}{2}$" Type X gypsum board on ceiling side 		1 h	-	-
GA FC 1144	<ul style="list-style-type: none"> • 1$\frac{3}{8}$" concrete • 30 gage steel deck with $\frac{5}{8}$" deep corrugations • 8" x 18 gage steel spaced at 24" o.c. • 2 layers of $\frac{1}{2}$" Type X gypsum board on ceiling side 		1 h	-	-

Floor/Ceiling – Gypsum Association

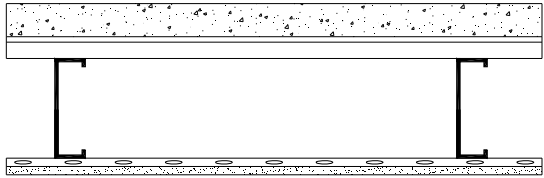
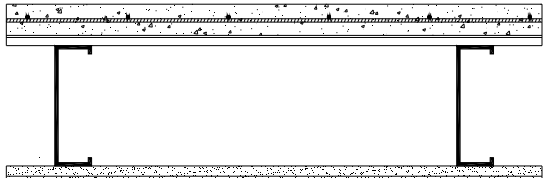
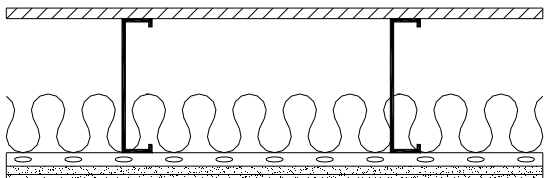
Source	Description	Fire Resistance Rating	Sound Transmission Class	Impact Insulation Class	
GA FC 1145	<ul style="list-style-type: none"> 2" lightweight concrete measured from top of flute 25 gage corrugated steel deck 6" x 1$\frac{5}{8}$" x 18 gage steel joist spaced at 24" o.c. resilient furring channels spaced at 24" o.c. 1 layer of $\frac{1}{2}$" Type X gypsum board on ceiling side 		1 h	-	-
GA FC 2116	<ul style="list-style-type: none"> 2 $\frac{1}{2}$" concrete 6" by 6" welded wire mesh No. 10 SWG steel wire 28 gage corrugated steel deck 7 $\frac{1}{4}$" x 18 gage steel joist spaced at 24" o.c. 2 layers of $\frac{5}{8}$" Type X gypsum board on ceiling side 		2 h	-	-
GA FC 4340 NRCC B-3163.2	<ul style="list-style-type: none"> subfloor of $\frac{5}{8}$" plywood 8" x 18 gage steel joist spaced at 16" o.c. resilient furring channels spaced 16" o.c. 3$\frac{1}{2}$" thick glass fiber insulation 2 layers of $\frac{1}{2}$" Type X gypsum board on ceiling side <p>NOTE: STC tested with $\frac{1}{4}$" carpet applied over $\frac{3}{8}$" foam pad</p>		1 h	50 to 54 (CAR-UND)	69 (CAR-UND)

Floor/Ceiling – Gypsum Association

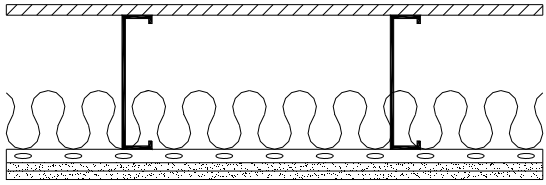
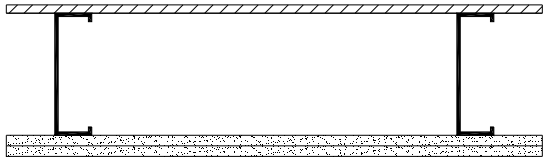
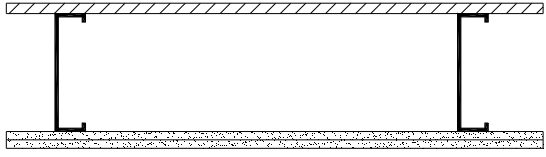
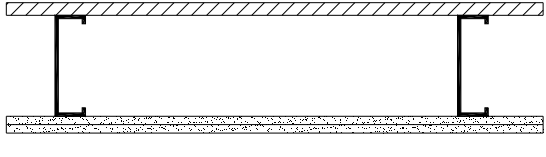
Source	Description	Fire Resistance Rating	Sound Transmission Class	Impact Insulation Class	
GA FC 4370 NRCC B-3163.1	<ul style="list-style-type: none"> subfloor of 5/8" plywood 8" x 18 gage steel joist spaced at 16" o.c. resilient furring channels spaced 16" o.c. 3 1/2" thick glass fibre insulation 2 layers of 1/2" Type X gypsum board on ceiling side 		1 h	45 to 49	39
GA FC 4490	<ul style="list-style-type: none"> subfloor of 1/2" plywood unspecified channel shaped steel joist spaced at 24" o.c. 2 layers of 5/8" Type X gypsum board on ceiling side <p>NOTE: As per GA-600-2012 ceiling provides one hour fire resistance protection for framing.</p>		1 h	35 to 39	-
GA FC 4502	<ul style="list-style-type: none"> subfloor of 5/8" plywood 7" x 18 gage steel joist spaced at 24" o.c. 2 layers of 1/2" Type X gypsum board on ceiling side 		1 h	<50*	<40*
GA FC 4503	<ul style="list-style-type: none"> subfloor of 3/4" plywood 6" x 16 gage steel joist spaced at 24" o.c. 2 layers of 1/2" Type X gypsum board on ceiling side 		1 h	<50*	<40*

* Estimated value as per Warnock (2008)

Floor/Ceiling – Gypsum Association

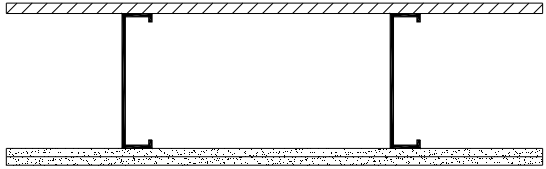
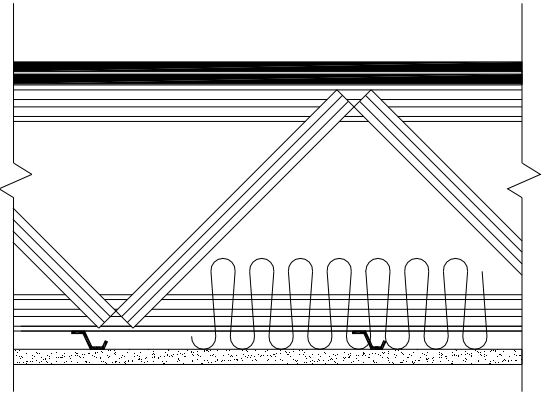
Source	Description	Fire Resistance Rating	Sound Transmission Class	Impact Insulation Class
GA FC 4504	<ul style="list-style-type: none"> • subfloor of 5/8" plywood • 8" x 18 gage steel joist spaced at 16" o.c. • 2 layers of 1/2" Type X gypsum board on ceiling side 			
GA FC 4515	<ul style="list-style-type: none"> • 2 layer flooring system (6 types) • trusses spaced a max. 48" o.c. • proprietary pre-fabricated light gauge steel truss systems, <ol style="list-style-type: none"> 1. Ultra-Span by Aegis Metal Framing 2. Amkey System by Allied Studco 3. Versa-Truss by Dale/Incor 4. Truss by Steel Construction Systems Inc. 5. NUTRUSS/NUTRUSS 3.0 by Nucon Steel Corporation 6. TrusSteel by TrusSteel, Division of ITW Building Components Inc. • resilient channels spaced 12" o.c. • optional mineral wool or glass fiber insulation • 1 layer of 5/8" Type X gypsum board on ceiling side 			
		1 h	-	-

Floor/Ceiling – Gypsum Association

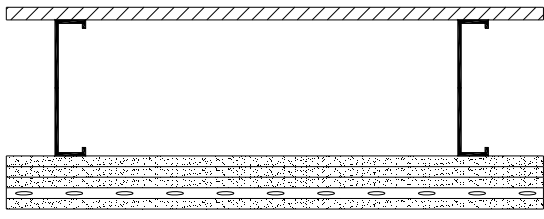
Source	Description	Fire Resistance Rating	Sound Transmission Class	Impact Insulation Class
<p>GA FC 4750</p> <p>a) NGC5004021 b) NGC7004068 c) NGC7004069</p>	<ul style="list-style-type: none"> • subfloor of 3/4" plywood • 8" x 16 gage steel joist spaced at 24" o.c. • 4 layers of 5/8" Type X gypsum board on ceiling side • resilient metal channels spaced 24" o.c. and applied perpendicular to joists over third layer of gypsum board 			
		2 h	48 ^a	37 ^b 60 ^c (CAR-UND)

Floor/Ceiling – Factory Mutual Research

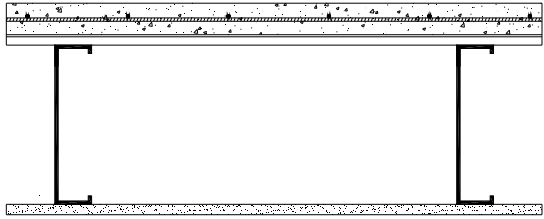
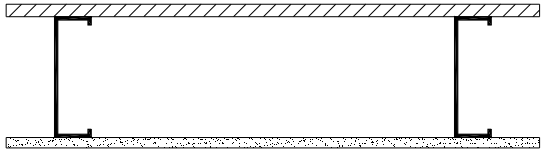
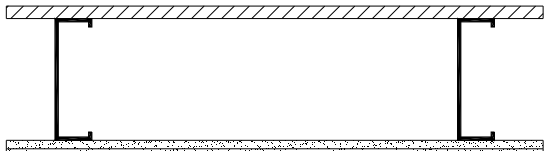
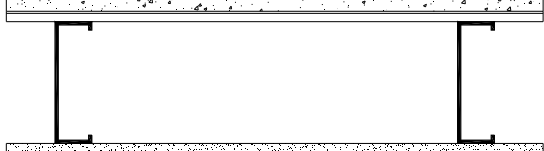
Source	Description	Fire Resistance Rating	Sound Transmission Class	Impact Insulation Class	
FM FC 179	<ul style="list-style-type: none"> • 2 ½" concrete • 6" by 6" welded wire mesh No. 10 SWG steel wire • 28 ga. (0.016" thick) steel deck with 9/16" deep corrugations • 9 ½" x 14 ga. (0.0785" thick) steel joist spaced at 24" o.c. • 1 layer of 5/8" gypsum board on ceiling side 		1 h	-	-
FM FC 184	<ul style="list-style-type: none"> • subfloor of 3/4" plywood • 7 ¼" x 18 ga. (0.050" thick) steel joist spaced at 24" o.c. • 1 layer of 5/8" gypsum board on ceiling side 		45 min	<50*	<40*
FM FC 196	<ul style="list-style-type: none"> • subfloor of 3/4" plywood • 7 ¼" x 18 ga. (0.052" thick) steel joist spaced at 24" o.c. • 2 layers of 1/2" gypsum board on ceiling side 		1 h	<50*	<40*
FM FC 218	<ul style="list-style-type: none"> • 1 ½" Lite-Crete foam concrete • 28 ga. (0.016" thick) steel deck with 9/16" deep corrugations • 7 ¼" x 18 ga. (0.053" thick) steel joist spaced at 24" o.c. • 1 layer of 5/8" gypsum board on ceiling side 		1 h	<50*	<40*

* Estimated value as per Warnock (2008)

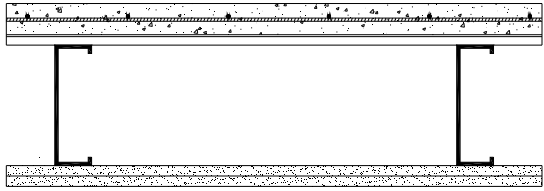
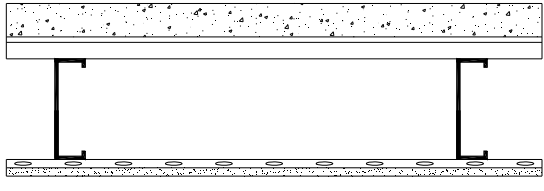

Floor/Ceiling – Factory Mutual Research

Source	Description	Fire Resistance Rating	Sound Transmission Class	Impact Insulation Class	
FM FC 224	<ul style="list-style-type: none"> • 2 ½" concrete • 6" by 6" welded wire mesh No. 10 SWG steel wire • 28 ga. (0.016" thick) steel deck with 9/16" deep corrugations • 7 ¼" x 18 ga. (0.052" thick) steel joist spaced at 24" o.c. • 2 layers of 5/8" Type X gypsum board on ceiling side 		2 h	50*	<40*
FM FC 245	<ul style="list-style-type: none"> • 2" lightweight concrete measured from top of the steel deck • 24 ga. (0.026" thick) steel deck with 1 5/16" deep corrugations • 6" x 18 ga. (0.05" thick) steel joist spaced at 24" o.c. • Resilient furring channels spaced at 24" o.c. • 1 layer of 1/2" gypsum board on ceiling side 		1 h	-	-

* Estimated value as per Warnock (2008)

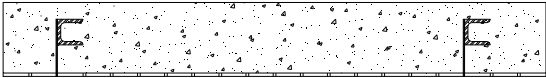
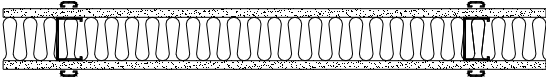
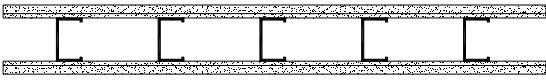

NON-LOAD BEARING WALL ASSEMBLIES

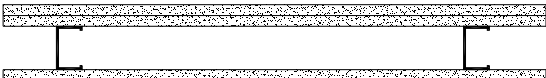
Non-Load Bearing Walls – Underwriters Laboratories of Canada

Source	Description	Fire Resistance Rating	Sound Transmission Class
ULC U202	<ul style="list-style-type: none"> paper backed wire fabric 38 mm x 38 mm x 5 mm thick steel channel spaced at 600 mm o.c. clips vermiculite concrete 		
		4 h	-
ULC U406 RAL-TL69-42	<ul style="list-style-type: none"> 64 mm x 33 mm x 0.5 mm thick steel studs spaced at 600 mm o.c. 38 mm mineral wool insulation 1 layer 12.7 mm gypsum board each side 		
		1 h	45
ULC W400	<ul style="list-style-type: none"> 64 mm x 35 mm x 0.5 mm thick steel studs spaced not less than 150 mm o.c. inner layer 6.4 mm gypsum board each side laminating compound outer layer 12.7 mm gypsum board on each side 		
		1 h	-
ULC W402	<ul style="list-style-type: none"> 64 mm x 35 mm x 0.5 mm thick steel studs spaced not less than 150 mm o.c. inner layer 9.5 mm gypsum board each side laminating compound outer layer 12.7 mm or 15.9 mm gypsum board on each side 		
		1 h	<45* (G 12.7mm)
ULC W404 RAL-TL75-73	<ul style="list-style-type: none"> 64 mm x 35 mm x 0.5 mm thick steel studs spaced not less than 150 mm o.c. inner layer 12.7 mm or 15.9 mm gypsum board each side optional adhesive outer layer 15.9 mm gypsum board on each side 		
		2 h	47 (G 15.9mm)

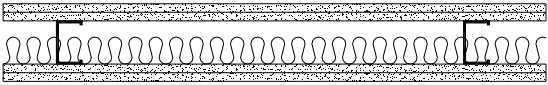

* Estimated value as per Warnock (2008)

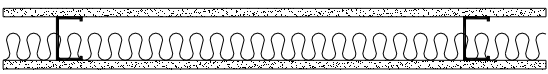
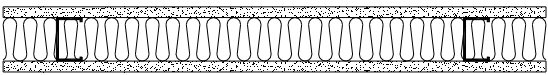
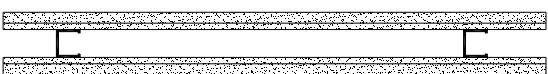
Non-Load Bearing Walls – Underwriters Laboratories of Canada

Source	Description	Fire Resistance Rating	Sound Transmission Class
ULC W406 a) CK654-40 b) USG800502 c) SA860932	<ul style="list-style-type: none"> 64 mm x 32 mm x 0.5 mm thick steel studs spaced 600 mm o.c. optional 38 mm mineral wool insulation 2 layers 12.7 mm gypsum board each side laminating adhesive between inner and outer layer 		
		2 h	54 ^a (RFB 40mm) 53 ^b (RFB 40mm) 52 ^c (RFB 40mm)
ULC W407 RAL-TL92-239	<ul style="list-style-type: none"> 92 mm x 35 mm x 0.5 mm thick steel studs spaced 600 mm o.c. 1 layer of 15.9 mm gypsum board on each side 		
		1 h	39
ULC W408 RAL-TL69-42	<ul style="list-style-type: none"> 64 mm x 35 mm x 0.5 mm thick steel studs spaced 600 mm o.c. 38 mm mineral wool insulation 1 layer of 12.7 mm gypsum board on each side 		
		1 h	45
ULC W409	<ul style="list-style-type: none"> 63 mm x 31 mm x 0.6 mm thick steel studs spaced 600 mm o.c. 70 mm glass fibre insulation 1 layer of 15.9 mm gypsum board on each side <p>** 45 min rating without insulation</p>		
		1 h ** 45 min	49*
ULC W410	<ul style="list-style-type: none"> 41 mm x 32 mm x 0.5 mm thick steel studs spaced 600 mm o.c. inner layer of 9.5 mm gypsum board on each side outer layer of 12.7mm or 15.9 mm gypsum board on each side 		
		1 h	27* (G 12.7mm) 29* (G 15.9mm)

* Estimated value as per Warnock (2008)

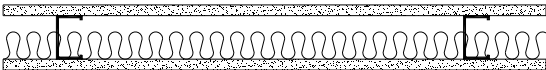
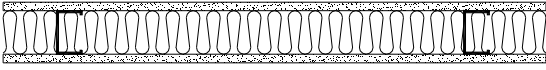
Non-Load Bearing Walls – Underwriters Laboratories of Canada

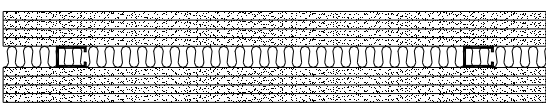
Source	Description	Fire Resistance Rating	Sound Transmission Class
ULC W412 a) RAL-TL69-42 b) USG 800506	<ul style="list-style-type: none"> 64 mm x 35 mm x 0.5 mm thick steel studs spaced 600 mm o.c. 38 mm mineral wool insulation 1 layer of 12.7 mm or 15.9 mm gypsum board on each side 		
		1 h	45 ^a (G 12.7mm) 46 ^b (G 15.9mm)
ULC W413	<ul style="list-style-type: none"> 64 mm x 35 mm x 0.5 mm thick steel studs spaced 600 mm o.c. 70 mm glass fibre insulation 1 layer of 12.7 mm gypsum board on each side 		
		45 min	47*
ULC W414	<ul style="list-style-type: none"> 63 mm x 31 mm x 0.6 mm thick steel channel spaced 600 mm o.c. 2 layers 12.7 mm or 15.9 mm gypsum board each side outer layer laminated to inner layer with laminating compound 		
		2 h	44* (G 12.7mm) 47* (G 15.9mm)
ULC W415 NRC TL-92-376	<ul style="list-style-type: none"> 92 mm x 35 mm x 0.5 mm thick steel studs spaced 600 mm o.c. 1 layer of 15.9 mm gypsum board on each side 		
		1 h	38
ULC W417 a) SA 830113 b) SA 830112	<ul style="list-style-type: none"> 41 mm x 31 mm x 0.5 mm thick steel studs spaced 600 mm o.c. optional 38 mm mineral wool insulation 4 hours - 4 layers of 12.7 mm gypsum board on each side 3 hours – 3 layers of 12.7 mm gypsum board on each side 		
		3 h 4 h	62 ^a (RFB 40mm) 59 ^b (RFB 40mm)

* Estimated value as per Warnock (2008)

Non-Load Bearing Walls – Underwriters Laboratories of Canada

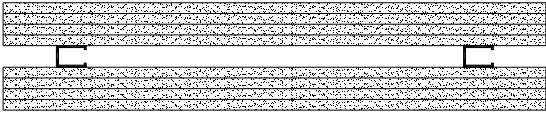
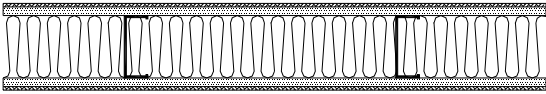
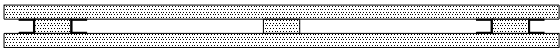
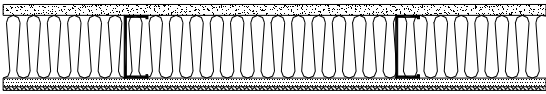
Source	Description	Fire Resistance Rating	Sound Transmission Class
ULC W418	<ul style="list-style-type: none"> 41 mm x 32 mm x 0.53 mm thick steel studs spaced 600 mm o.c. 4 hours - 4 layers of 12.7 mm or 15.9 mm gypsum board on each side 3 hours – 3 layers of 12.7 mm or 15.9 mm gypsum board on each side 		
		3 h 4 h	50* (G 12.7mm) 46* (G 12.7mm)
ULC W419	<ul style="list-style-type: none"> 92 mm x 32 mm x 0.5 mm thick steel studs spaced 400 mm o.c. 90 mm mineral wool insulation inner layer of 12.7 mm tile backer board each side outer layer of 5.2 mm ceramic tile each side, joints filled with wall grout 		
		1 h	54*
ULC W421	<ul style="list-style-type: none"> 38 mm x 40 mm x 0.6 mm channel studs spaced 1220 mm o.c. 1 layer 38 mm thick x 1.22 m wide mineral and fibre board each side 38 mm thick x 101.6 mm wide mineral and fibre board backing strips 		
		2 h	-
ULC W423	<ul style="list-style-type: none"> 92 mm x 32 mm x 0.5 mm thick steel studs spaced 400 mm o.c. 90 mm mineral wool insulation inner layer of 12.7 mm tile backer board on one side, designated "Durock" outer layer of 5.2 mm ceramic tile, joints filled with wall grout 1 layer of 12.7 mm or 15.9 mm gypsum board on one side. 		
		1 h	51* (G 12.7mm) 52* (G 15.9mm)

* Estimated value as per Warnock (2008)

Non-Load Bearing Walls – Underwriters Laboratories of Canada

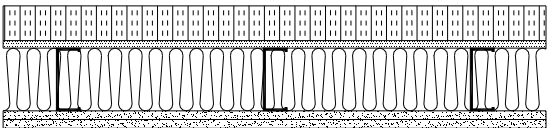
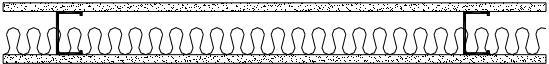
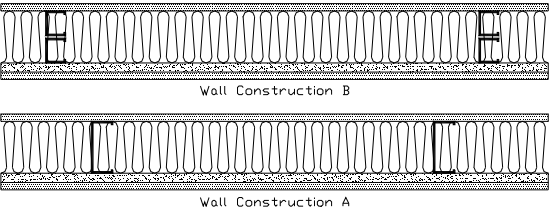
Source	Description	Fire Resistance Rating	Sound Transmission Class
ULC W425	<ul style="list-style-type: none"> 92 mm x 35 mm x 0.9 mm thick steel studs spaced 305 mm o.c. 90 mm glass fibre insulation 38 mm x 12.7 mm x 1.2 mm thick channel bracing inserted in the knockouts and supported by angles 0.05 mm clear polyethylene 2 layers of 12.7 mm gypsum board on one side see ULC description for exterior insulation and stucco finish details 		
		2 h	-
ULC W433 RAL-TL69-42	<ul style="list-style-type: none"> 64 mm x 35 mm x 0.5 mm thick steel studs spaced 600 mm o.c. 38 mm mineral wool insulation designated "Acoustical Fire Batts" 1 layer of 12.7 mm gypsum board on each side 		
		1 h	45
ULC W436	<ul style="list-style-type: none"> Wall A – 90 mm x 35 mm x 0.62 mm thick steel studs spaced at 600 mm o.c. 76 mm mineral wool insulation 1 layer of 12.7 mm or 15.9 mm gypsum board on one side 1 layer of 12.7 mm reinforced cement board, designated "Perma Base" on each side 		
		1 h	51* (Wall A, G 12.7mm)

* Estimated value as per Warnock (2008)

Non-Load Bearing Walls – Underwriters Laboratories of Canada

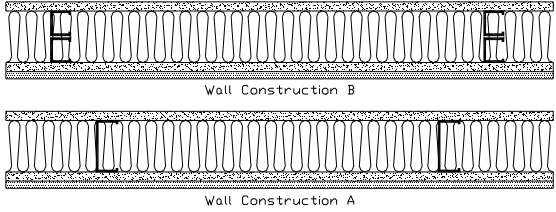
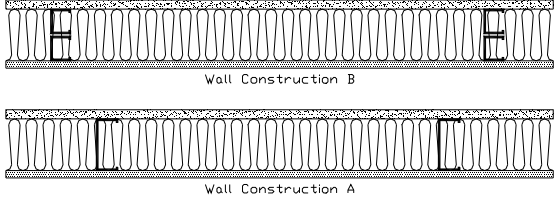
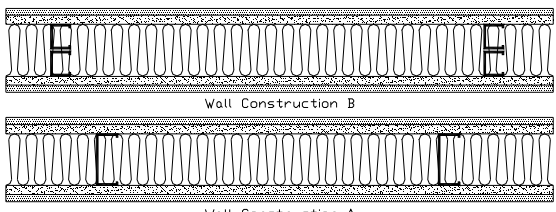
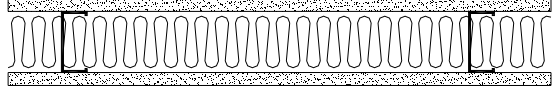
Source	Description	Fire Resistance Rating	Sound Transmission Class		
ULC W437	<ul style="list-style-type: none"> Wall A – 90 mm x 35 mm x 0.62 mm thick steel studs spaced at 600 mm o.c. 76 mm mineral wool insulation 1 layer of 12.7 mm or 15.9 mm gypsum board on each side 1 layer of 12.7 mm reinforced cement board, designated “Perma Base” on one side 		<table border="1"> <tr> <td>1 h</td> <td>52* (Wall A, G 12.7mm) 54* (Wall A, G 15.9mm)</td> </tr> </table>	1 h	52* (Wall A, G 12.7mm) 54* (Wall A, G 15.9mm)
1 h	52* (Wall A, G 12.7mm) 54* (Wall A, G 15.9mm)				
ULC W438	<ul style="list-style-type: none"> Wall A – 90 mm x 32 mm x 0.62 mm thick steel studs spaced at 600 mm o.c. 76 mm mineral wool insulation 1 layer of 15.9 mm gypsum board on one side 1 layer of 12.7 mm reinforced cement board, designated “Perma Base” on other side 		<table border="1"> <tr> <td>1 h</td> <td>49* (Wall A)</td> </tr> </table>	1 h	49* (Wall A)
1 h	49* (Wall A)				
ULC W439	<ul style="list-style-type: none"> Wall A – 90 mm x 32 mm x 0.62 mm thick steel studs spaced at 600 mm o.c. 89 mm mineral wool insulation 1 layer of 12.7 mm or 15.9 mm gypsum board on each side 1 layer of 12.7 mm reinforced cement board, designated “Perma Base” on each side 		<table border="1"> <tr> <td>2 h</td> <td>55* (Wall A, G 12.7mm) 56* (Wall A, G 15.9mm)</td> </tr> </table>	2 h	55* (Wall A, G 12.7mm) 56* (Wall A, G 15.9mm)
2 h	55* (Wall A, G 12.7mm) 56* (Wall A, G 15.9mm)				
ULC W440 USG910617	<ul style="list-style-type: none"> 89 mm x 32 mm x 0.5 mm thick steel studs spaced at 610 mm o.c. 76 mm mineral wool insulation 1 layer of 19.1 mm gypsum board on each side 		<table border="1"> <tr> <td>2 h</td> <td>50</td> </tr> </table>	2 h	50
2 h	50				

* Estimated value as per Warnock (2008)

Non-Load Bearing Walls – Underwriters Laboratories of Canada

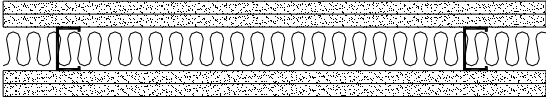
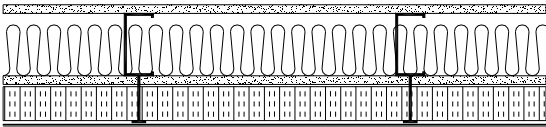
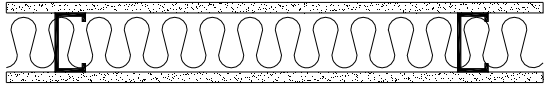
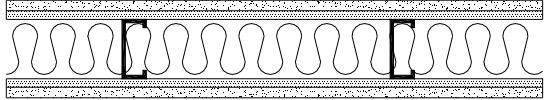
Source	Description	Fire Resistance Rating	Sound Transmission Class
ULC W441 a) SA910507 b) USG910907	<ul style="list-style-type: none"> 64 mm x 32 mm x 0.5 mm thick steel studs spaced at 610 mm o.c. 50 mm mineral wool insulation 2 layers of 19.1 mm gypsum board on each side 		
		4 h	56 ^{a & b}
ULC W442	<ul style="list-style-type: none"> 92 mm x 40 mm x 1.13 mm thick steel studs spaced at 400 mm o.c. 75 mm mineral fiber insulation 12.7 mm gypsum board on interior side 15.9 mm gypsum board on exterior side 50 mm polystyrene rigid insulation boards mechanical fastener system with 4 mm dia. x 100 mm long <p>* Fire exposure from exterior side ** Fire exposure from interior side</p>		
		1 h * 1-½ h **	-
ULC W447	<ul style="list-style-type: none"> 92 mm x 32 mm x 0.53 mm thick steel studs spaced at 610 mm o.c. mineral wool insulation 1 layer of 15.9 mm gypsum board on each side 		
		1 h	-
UL W448	<ul style="list-style-type: none"> 93 mm x 33 mm x 0.5 mm thick steel studs spaced at 406 mm o.c. nom. 76 mm mineral wool batts, min. 54 kg/m³, friction fit inner layer 12.7 mm mineral and fiber board designated made by Homasote Co. on each side outer layer 15.9 mm gypsum board on each side 		
		1 h	-

Non-Load Bearing Walls – Underwriters Laboratories of Canada

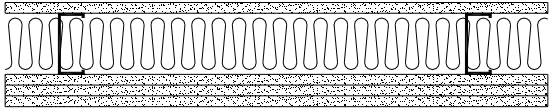
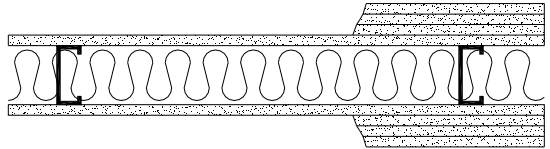
Source	Description	Fire Resistance Rating	Sound Transmission Class		
ULC W451	<ul style="list-style-type: none"> • 89 mm x 32 mm x 0.46 mm thick steel studs spaced at 610 mm o.c. • optional mineral fiber insulation produced from rock, slag or glass • 1 layer of 15.9 mm gypsum board on one side • 3 layers of 15.9 mm gypsum board on other side 				
		2 h	-		
ULC W453 a) SA870717 b) SA860620 c) RAL-TL90-166 d) USG860808 e) USG910617 f) SA830112 g) SA830113 h) USG910907	<ul style="list-style-type: none"> • min. 0.46mm thick steel studs spaced at 610 mm o.c. • mineral wool insulation optional except where required as noted by asterisk and described below • stud depth, drywall layers, drywall thickness, and corresponding rating as shown <p>* 38 mm mineral wool insulation ** 76 mm mineral wool insulation *** 51 mm mineral wool insulation</p>				
			# Layer & Size	Stud Depth	
		1 h	1-15.9	89	49 ^a (RFB 76) 51 ^{b&c} (RFB 89) 40 ^d (NI)
		1 h	1-12.7	64*	
		1 h	1-19.1	41	
		2 h	2-12.7	41	
		2 h	2-15.9	41	
		2 h	1-19.1	89**	50 ^e
		3 h	3-12.7	41	59 ^f (RFB 38)
		3 h	2-19.1	41	
3 h	3-15.9	41			
4 h	4-15.9	41			
4 h	4-12.7	41	62 ^g (RFB 38)		
4 h	2-19.1	64***	56 ^h		

Non-Load Bearing Walls – Underwriters Laboratories of Canada

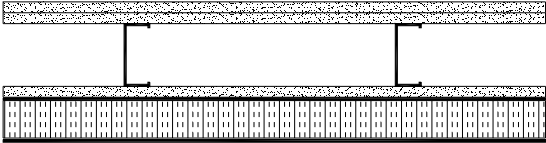
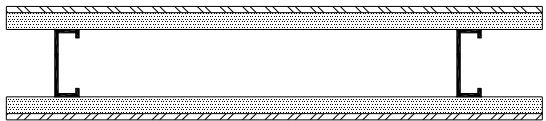
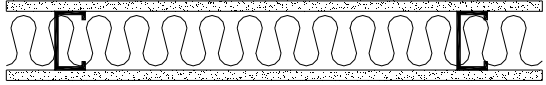
Source	Description	Fire Resistance Rating	Sound Transmission Class
ULC W456	<ul style="list-style-type: none"> 92 mm x 40 mm x 0.92 mm thick steel studs spaced at 406 mm o.c. inner 2 layers of 15.9 mm Type X gypsum board 1 layer of 15.9 mm gypsum board on other side 150 mm max. thick polystyrene insulation boards components in exterior wall insulation and finish system by Durabond Products Ltd. 		
		2 h	-
ULC W457	<ul style="list-style-type: none"> 102 mm x 63.5 mm x 1.802 mm thick steel studs spaced at 600 mm o.c. inner layer of 25 mm mineral and fibre board on each side outer layer of 9.5 mm steel skin cementitious panels designated "Durasteel" 		
		4 h	-
ULC W458	<ul style="list-style-type: none"> 92 mm x 32 mm x 0.838 mm thick steel studs spaced at 600 mm o.c. optional mineral wool or glass fibre insulation 1 layer of 15.9 mm gypsum board on each side non-metallic plumbing system components attached to steel lumber bracing 		
		1 h	-

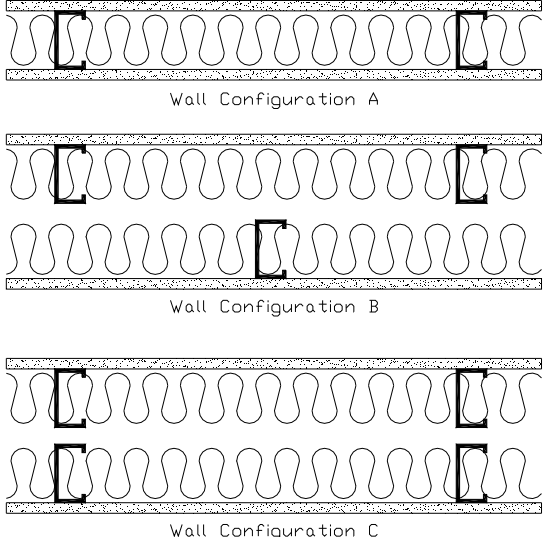
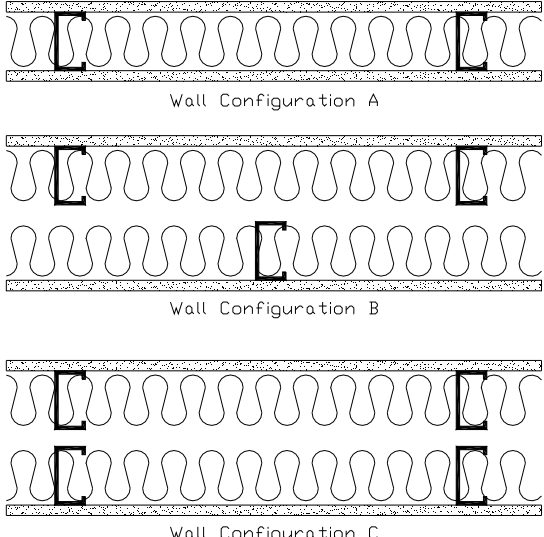

Non-Load Bearing Walls – Underwriters Laboratories of Canada

Source	Description	Fire Resistance Rating	Sound Transmission Class
<p>ULC W459</p>	<ul style="list-style-type: none"> 89 mm x 38 mm x 0.56 mm steel stud spaced as follows: Configuration A: 406 mm or 610 mm o.c. 89 mm glass fiber insulation with nom. density of 15 kg/m³ 1 layer of 15.9 mm “QuietRock” soundproof drywall on each side 	 <p>Wall Configuration A</p> <p>Wall Configuration B</p> <p>Wall Configuration C</p>	<p>1 h</p> <p>-</p>
<p>ULC W460</p> <p>RAL TL07-069</p> <p>EQ</p>	<ul style="list-style-type: none"> 89 mm x 30 mm x 0.37 mm proprietary steel stud (ClarkDietrich) spaced as follows: Configuration A: 406 mm or 610 mm o.c. 89 mm glass fiber insulation with nom. density of 15 kg/m³ 1 layer of 15.9 mm “QuietRock” soundproof drywall on each side 	 <p>Wall Configuration A</p> <p>Wall Configuration B</p> <p>Wall Configuration C</p>	<p>1 h</p> <p>55 (Configuration A)</p>

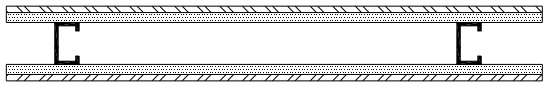
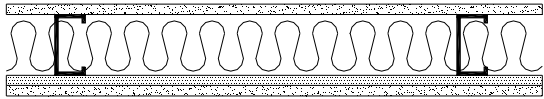
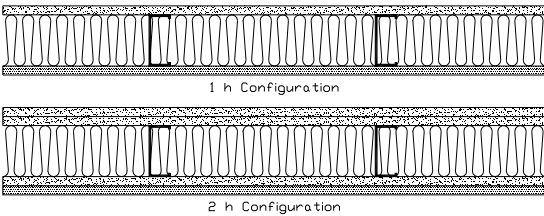
Non-Load Bearing Walls – Underwriters Laboratories of Canada

Source	Description	Fire Resistance Rating	Sound Transmission Class
ULC W461	<ul style="list-style-type: none"> 63.5 mm x 41 mm x 1.802 mm thick steel studs spaced at 600 mm o.c. inner layer of 15 mm mineral and fibre board on each side outer layer of 6.4 mm steel skin cementitious panels designated "Durasteel" for 1½ hours outer layer of 9.5 mm steel skin cementitious panels designated "Durasteel" for 2 hours 		
		1½ h 2 h	-
ULC W462	<ul style="list-style-type: none"> 89 mm x 38 mm x 0.53 mm thick steel studs spaced at 610 mm o.c. glass fibre insulation 1 layer of 15.9 mm gypsum board on one side 1 layer of 12 mm mineral and fibre board and 15.9 mm gypsum board on other side 		
		1 h	-
ULC W464	<ul style="list-style-type: none"> 92 mm x 32 mm x 0.455 mm thick steel studs spaced at 406 mm o.c. 75 mm mineral wool insulation 1 hour – 1 layer of 15.9 mm gypsum board on one side and 12.7 mm, 15.9 mm, 19.1 mm or 25.4 mm mineral and fibre board on other side 2 hour – 2 layers of 15.9 mm gypsum board on one side and 1 layer of 15.9 mm gypsum board with 12.7 mm, 15.9 mm, 19.1 mm or 25.4 mm mineral and fibre board on other side 		
		1 h	-
		2 h	-

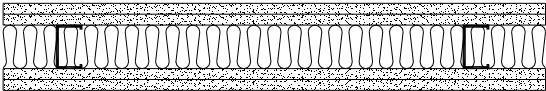
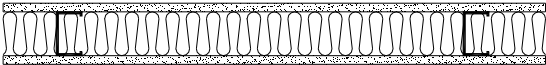
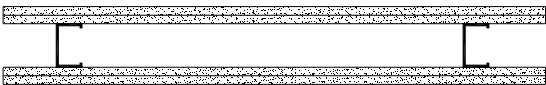
Non-Load Bearing Walls – Underwriters Laboratories of Canada

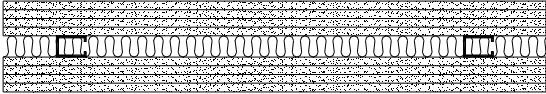
Source	Description	Fire Resistance Rating	Sound Transmission Class
ULC W465	<ul style="list-style-type: none"> 63.5 mm x 32 mm x 0.505 mm thick steel studs spaced at 610 mm o.c. mineral wool insulation 2 layers 15.9 mm gypsum board on each side 		
		2 h	-
ULC W467	<ul style="list-style-type: none"> 63 mm x 31 mm x 0.6 mm thick steel studs spaced at 600 mm o.c. 65 mm mineral wool insulation 1 layer 12.7 mm gypsum board on each side 		
		1 h	-
ULC W468	<ul style="list-style-type: none"> 63 mm x 31 mm x 0.6 mm thick steel studs spaced at 600 mm o.c. 2 layers 12.7 mm or 15.9 mm gypsum board on each side 		
		2 h	-
ULC W469	<ul style="list-style-type: none"> 92 mm x 35 mm x 0.5 mm thick steel studs spaced at 600 mm o.c. 1 layer 15.9 mm gypsum board on each side 		
		1 h	-
ULC W470	<ul style="list-style-type: none"> 41 mm x 31 mm x 0.5 mm thick steel studs spaced 600 mm o.c. optional 38 mm mineral wool insulation 4 hours - 4 layers of 12.7 mm gypsum board on each side 3 hours – 3 layers of 12.7 mm gypsum board on each side 		
		3 h 4 h	-

Non-Load Bearing Walls – Underwriters Laboratories of Canada

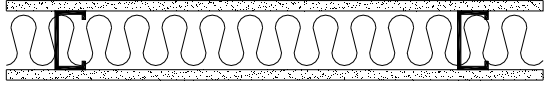
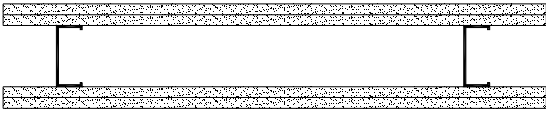
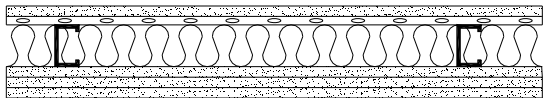
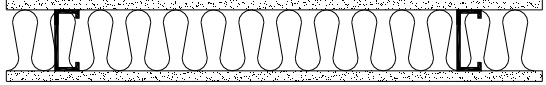
Source	Description	Fire Resistance Rating	Sound Transmission Class
ULC W471	<ul style="list-style-type: none"> 89 mm x 38 mm x 0.48 mm thick steel studs spaced at 406 mm or 610 mm o.c. 76 mm mineral wool insulation 15.9 mm gypsum board on each side 		
		1 h	-
ULC W472	<ul style="list-style-type: none"> 89 mm x 38 mm x 0.48 mm thick steel studs spaced at 406 mm or 610 mm o.c. 76 mm mineral wool insulation 2 layers 15.9 mm gypsum board on each side 		
		2 h	-
ULC W477 EQ	<ul style="list-style-type: none"> 63.5 mm x 31.75 mm x 0.627 mm thick steel studs spaced at 610 mm o.c. optional glass fibre or mineral wool insulation optional resilient furring channels spaced 610 mm and 16 mm gypsum board on one side 3 layers 16 mm gypsum board on other side 		
		2 h	-
ULC W478	<ul style="list-style-type: none"> 92 mm x 0.627 mm thick steel studs spaced at 610 mm o.c. optional glass fibre or mineral wool insulation 16 mm gypsum board on each side 		
		1 h	-

Non-Load Bearing Walls – Underwriters Laboratories of Canada

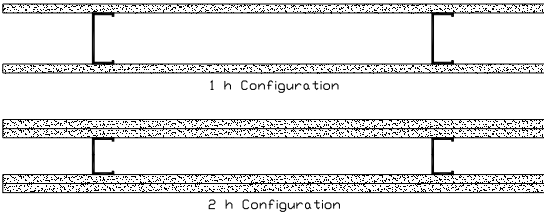
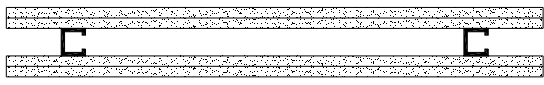
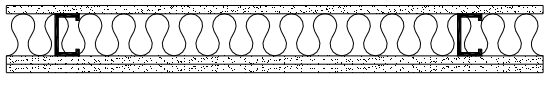
Source	Description	Fire Resistance Rating	Sound Transmission Class
ULC W479 EQ	<ul style="list-style-type: none"> 92 mm x 32 mm x 0.42 mm thick proprietary steel studs (Bailey Metal Products Ltd.) spaced at 610 mm o.c. optional glass fibre or mineral wool insulation 1 layer 15.9 mm gypsum board on each side 	 1 h	-
ULC W480 EQ	<ul style="list-style-type: none"> 92 mm x 0.381 mm for one hour and 64 mm x 0.381 mm for two hours thick proprietary steel studs (ClarkDietrich) spaced at 610 mm o.c. optional glass fibre or mineral wool insulation 1 hour - 1 layer of 16 mm gypsum board on each side 2 hours – 2 layers of 16 mm gypsum board on each side 	 1 h 2 h	-
ULC W482	<ul style="list-style-type: none"> 41.3 mm x 30 mm x 0.63 mm thick steel studs spaced at 610 mm o.c. 2 layers of 16 mm gypsum board on each side 	 2 h	-
ULC W484	<ul style="list-style-type: none"> 63.5 mm x 31.75 mm x 0.51 mm thick steel studs spaced at 610 mm o.c. 63 mm glass fibre insulation 1 layer 12.7 mm gypsum board on one side 2 layers 12.7 mm gypsum board on other side 	 1 h	-

Non-Load Bearing Walls – Underwriters Laboratories of Canada

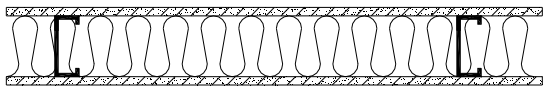
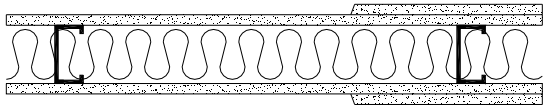
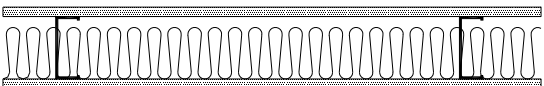
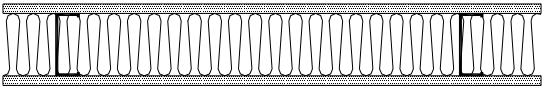
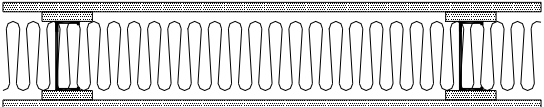
Source	Description	Fire Resistance Rating	Sound Transmission Class
ULC W490	<ul style="list-style-type: none"> 92 mm x 35 mm x 0.91 mm thick steel studs spaced at 610 mm o.c. mineral wool insulation 12 mm magnesium oxide panels designated as “Magnum Board” on each side 		
		1 h	-
ULC W496	<ul style="list-style-type: none"> 92 mm x 38 mm FOR ONE Hx 22 MSG steel studs spaced at 610 mm o.c. optional glass fibre or mineral wool insulation optional resilient furring channels spaced 610 mm ½ hour - 1 layer of 15.9 mm gypsum board on each side 1 hour – 2 layers of 15.9 mm gypsum board on each side 		
		½ h 1 h	-
ULC W497	<ul style="list-style-type: none"> 92 mm x 38 mm x 22 MSG, for 1, 1½ and 2 hour, and 102 mm x 38 mm x 22 MSG, for 3 hour, steel studs spaced at 605 mm o.c. 76 mm mineral wool insulation for 1 and 1½ hour 102 mm mineral wool insulation for 2 and 3 hour 1 hour - 1 layer of 10 mm magnesium oxide panels designated as “Type Dragonboard” on each side 1½ and 2 hour – 1 layer of 14 mm magnesium oxide panels designated as “Type Dragonboard” on each side 3 hour - 1 layer of 14 mm over 75 mm wide strip of 14 mm magnesium oxide panels designated as “Type Dragonboard” on each side 	<p>1 OR 1-1/2 HR CONFIGURATION</p> 	
		<p>2 HR CONFIGURATION</p> 	
		<p>3 HR CONFIGURATION</p> 	
		1 h 1½ h 2 h 3 h	-

Non-Load Bearing Walls – Underwriters Laboratories of Canada

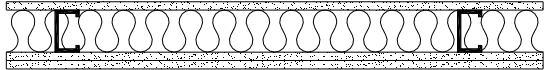
Source	Description	Fire Resistance Rating	Sound Transmission Class
ULC W498	<ul style="list-style-type: none"> • 63.5 mm x 31.75 mm x 0.51 mm thick steel studs spaced at 610 mm o.c. • 63 mm glass fibre insulation • 1 layer 12.7 mm gypsum board on one side • 2 layers 12.7 mm gypsum board on other side 		-
		1 h	-

NOTE: ULC Certification Bulletin No. 2003-08 (dated August 21, 2003) provides an official ULC permission for ULC listed and package labelled mineral fibre building insulation (processed from rock, slag and glass only) to be used in ULC non-load bearing wall assembly designs consisting of gypsum wallboard and steel or wood studs with a fire resistance rating not exceeding 2 hours when illustrated without insulation, without detracting from the rating assigned to the assembly.

Non-Load Bearing Shaft Walls – Underwriters Laboratories of Canada

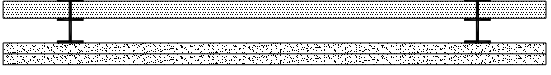
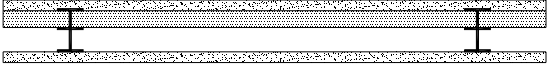
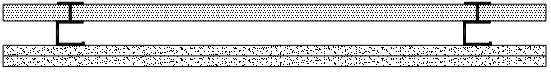
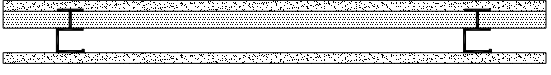
Source	Description	Fire Resistance Rating	Sound Transmission Class
ULC W446 a) Intertek 3123470EEV b) RAL 437362 1976	System A <ul style="list-style-type: none"> 64 mm x 38 mm x 0.53 mm thick “I” shaped steel studs spaced at 610 mm o.c. 25.4 mm gypsum board on one side 2 layers of 12.7 mm or 15.9 mm gypsum board on other side optional resilient channels 		
		2 h	39* (G 12.7mm) 41* (G 15.9mm) 50 ^a (GFB/RFB 95mm G 15.9mm RC) 50 ^b (GFB/RFB 108mm)
	System B <ul style="list-style-type: none"> 64 mm x 38 mm x 0.53 mm thick “I” shaped steel studs spaced at 610 mm o.c. inner layer of 25.4 mm gypsum board on one side 1 layer of 12.7 mm or 15.9 mm gypsum board on each side optional resilient channels 		
		2 h	50 ^a (GFB/RFB 95mm RC)
	System C <ul style="list-style-type: none"> 64 mm x 38 mm x 0.53 mm thick “C-T” or “C-H” shaped steel studs spaced at 610 mm o.c. 1 layer 25.4 mm gypsum board on one side 2 layers of 12.7 mm or 15.9 mm gypsum board on other side optional resilient channels 		
		2 h	50 ^a (GFB/RFB 95mm G 15.9mm RC) 50 ^b (GFB/RFB 108mm)
	System D <ul style="list-style-type: none"> 64 mm x 38 mm x 0.53 mm thick “C-T” or “C-H” shaped steel studs spaced at 610 mm o.c. inner layer of 25.4 mm gypsum board on one side, with 12.7 mm or 15.9 mm gypsum board outer layer 1 layer of 12.7 mm or 15.9 mm gypsum board on other side optional resilient channels 		
		2 h	50 ^a (GFB/RFB 95mm RC)

* Estimated value as per Warnock (2008)

Non-Load Bearing Shaft Walls – Underwriters Laboratories of Canada

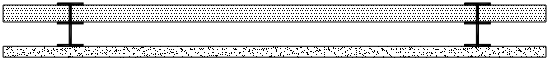
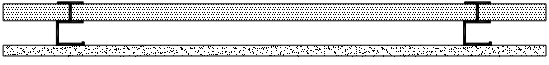
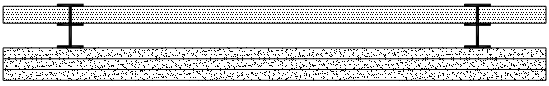
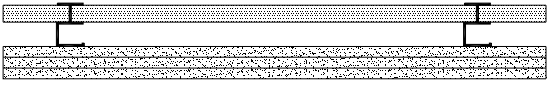
Source	Description	Fire Resistance Rating	Sound Transmission Class
ULC W446 (cont.) a) Intertek 3123470EEV	System E <ul style="list-style-type: none"> • 64 mm x 38 mm x 0.53 mm thick “I” shaped steel studs spaced at 610 mm o.c. • 1 layer 25.4 mm gypsum board on one side • 1 layer of 15.9 mm gypsum board on other side 		1 h 42 ^a (GFB/RFB 80mm)
	System F <ul style="list-style-type: none"> • 64 mm x 38 mm x 0.53 mm thick “C-T” or “C-H” shaped steel studs spaced at 610 mm o.c. • 1 layer 25.4 mm gypsum board on one side • 1 layer of 15.9 mm gypsum board on other side 		1 h 42 ^a (GFB/RFB 80mm)
	System G <ul style="list-style-type: none"> • 64 mm x 38 mm x 0.53 mm thick “I” shaped steel studs spaced at 610 mm o.c. • 1 layer 25.4 mm gypsum board on one side • 3 layers of 15.9 mm gypsum board on other side 		3 h -
	System H <ul style="list-style-type: none"> • 64 mm x 38 mm x 0.53 mm thick “C-T” or “C-H” shaped steel studs spaced at 610 mm o.c. • 1 layer 25.4 mm gypsum board on one side • 3 layers of 15.9 mm gypsum board on other side 		3 h -

Non-Load Bearing Shaft Walls – Underwriters Laboratories of Canada

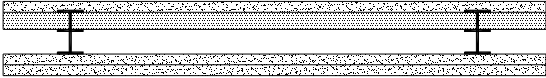
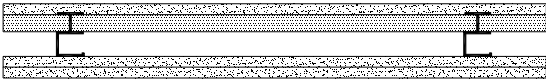
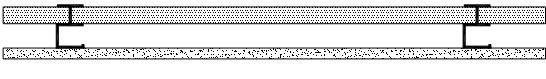
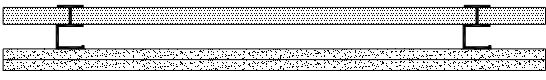
Source	Description	Fire Resistance Rating	Sound Transmission Class
ULC W446 (cont.)	System I <ul style="list-style-type: none"> 64 mm x 38 mm x 0.53 mm thick “I” shaped steel studs spaced at 610 mm o.c. inner layer of 25.4 mm gypsum board on one side, with 15.9 mm gypsum board outer layer 2 layers of 15.9 mm gypsum board on other side 		
		3 h	-
	System J <ul style="list-style-type: none"> 64 mm x 38 mm x 0.53 mm thick “C-T” or “C-H” shaped steel studs spaced at 610 mm o.c. inner layer of 25.4 mm gypsum board on one side, with 15.9 mm gypsum board outer layer 2 layers of 15.9 mm gypsum board on other side 		
		3 h	-
ULC W452	System A <ul style="list-style-type: none"> 64 mm deep x 0.46 mm thick “C-H” shaped steel studs spaced at 610 mm o.c. 1 layer 25.4 mm gypsum liner board panels on one side 1 layer of 15.9 mm gypsum wallboard on other side 		
		1 h	-
	System B <ul style="list-style-type: none"> 64 mm deep x 0.46 mm thick “C-H” shaped steel studs spaced at 610 mm o.c. 1 layer 25.4 mm gypsum liner board panels on one side 2 layers of 12.7 mm or 15.9 mm gypsum wallboard on other side 		
		2 h	-

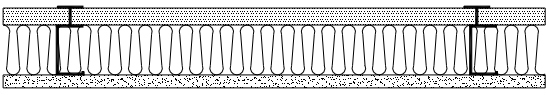
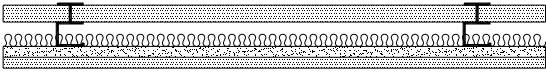
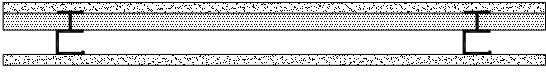
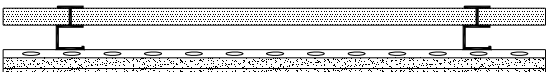

Non-Load Bearing Shaft Walls – Underwriters Laboratories of Canada

Source	Description	Fire Resistance Rating	Sound Transmission Class
ULC W452 (cont.)	<p>System C</p> <ul style="list-style-type: none"> • 102 mm deep x 0.46 mm thick “C-H” shaped steel studs spaced at 610 mm o.c. • 75 mm min. mineral wool batts • 1 layer 25.4 mm gypsum liner board panels on one side • 1 layer of 19.1 mm gypsum wallboard on other side 	 <p>2 h</p>	-
	<p>System D</p> <ul style="list-style-type: none"> • 64 mm deep x 0.84 mm thick “C-H” shaped steel studs spaced at 610 mm o.c. • 1 layer 25.4 mm gypsum liner board panels on one side • 38 mm min. mineral wool batts • 1 layer of 15.9 mm gypsum wallboard and 1 layer of 12.7 mm or 15.9 mm mineral and fibre board designated “Durock” on other side 	 <p>2 h</p>	-
	<p>System E</p> <ul style="list-style-type: none"> • 64 mm deep x 0.46 mm thick “C-H” shaped steel studs spaced at 610 mm o.c. • 1 layer 25.4 mm gypsum liner board panels on one side • 1 layer of 12.7 mm or 15.9 mm gypsum wallboard on each side 	 <p>2 h</p>	-
	<p>System F</p> <ul style="list-style-type: none"> • 64 mm deep x 0.46 mm thick “C-H” shaped steel studs spaced at 610 mm o.c. • 1 layer 25.4 mm gypsum liner board panels on one side • furring channels spaced at 610 mm o.c. • 2 layers of 12.7 mm or 15.9 mm gypsum wallboard on other side 	 <p>2 h</p>	-

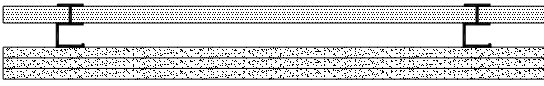
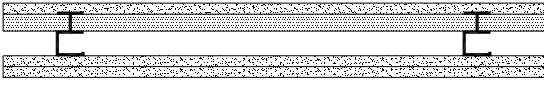
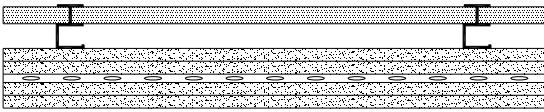
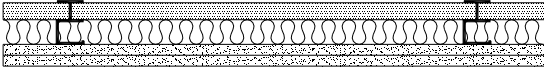
Non-Load Bearing Shaft Walls – Underwriters Laboratories of Canada

Source	Description	Fire Resistance Rating	Sound Transmission Class
ULC W452 (cont.)	System G <ul style="list-style-type: none"> 64 mm deep x 0.46 mm thick “C-H” shaped steel studs spaced at 610 mm o.c. 1 layer 25.4 mm gypsum liner board panels on one side 3 layers of 15.9 mm gypsum wallboard on other side 		
		3 h	-
	System H <ul style="list-style-type: none"> 64 mm deep x 0.46 mm thick “C-H” shaped steel studs spaced at 610 mm o.c. 1 layer 25.4 mm gypsum liner board panels and 1 layer of 15.9 mm gypsum wallboard on one side 2 layers of 15.9 mm gypsum wallboard on other side 		
		3 h	-
	System I <ul style="list-style-type: none"> 64 mm deep x 0.46 mm thick “C-H” shaped steel studs spaced at 610 mm o.c. 1 layer 25.4 mm gypsum liner board panels on one side 4 layers of 19.1 mm gypsum wallboard on other side furring channels spaced at 610 mm o.c. and applied over second layer 		
		4 h	-
ULC W481	System A <ul style="list-style-type: none"> 63.5 mm deep x 0.627 mm thick “C-T” or “C-H” shaped steel studs spaced at 610 mm o.c. 1 layer 25 mm gypsum liner board panels on one side 2 layers of 16 mm gypsum board on other side optional mineral wool or glass fibre insulation 		
			2 h

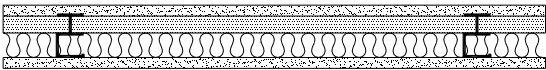
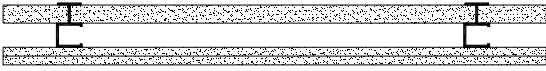
Non-Load Bearing Shaft Walls – Underwriters Laboratories of Canada

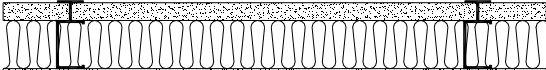
Source	Description	Fire Resistance Rating	Sound Transmission Class
ULC W481 (cont.)	System B <ul style="list-style-type: none"> 63.5 mm deep x 0.627 mm thick “C-T” or “C-H” shaped steel studs spaced at 610 mm o.c. 1 layer 25 mm gypsum liner board panels and 1 layer of 16 mm gypsum board on one side 1 layer of 16 mm gypsum board on other side optional mineral wool or glass fibre insulation 		
		2 h	-
ULC W506	<ul style="list-style-type: none"> 64 mm x 35 mm x 0.5 mm thick steel “C-H” shaped studs spaced at 600 mm o.c. 1 layer 25 mm gypsum board on one side 2 layers 12.7 mm gypsum board on other side 		
		2 h	-
ULC W507	<ul style="list-style-type: none"> 64 mm x 35 mm x 0.5 mm thick steel “C-H” shaped studs spaced at 600 mm o.c. 1 layer 25 mm gypsum board on one side 2 layers 15.9 mm gypsum board on other side 		
		2 h	-
ULC W508 USG910913	<ul style="list-style-type: none"> 100 mm x 38 mm x 0.5 mm thick steel “C-H” shaped studs spaced at 610 mm o.c. 76 mm mineral wool insulation 1 layer 25.4 mm gypsum board on one side 1 layer 19.1 mm gypsum board on other side 		
		2 h	52

Non-Load Bearing Shaft Walls – Underwriters Laboratories of Canada

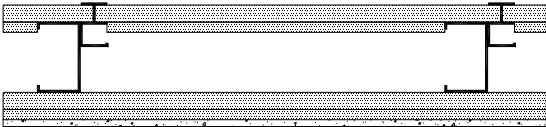
Source	Description	Fire Resistance Rating	Sound Transmission Class
ULC W512	<ul style="list-style-type: none"> • 64 mm deep x 0.5 mm thick “C-H” shaped steel studs spaced at 600 mm o.c. • 1 layer of 25 mm gypsum board on one side • 2 layers of 12.7 mm gypsum board on other side 		
		2 h	-
ULC W513	<ul style="list-style-type: none"> • 102 mm deep x 1.9 mm thick channel shaped studs fastened to 64 mm deep, 0.91 mm thick “C-H” shaped channel spaced at 600 mm o.c. • 1 layer of 25 mm mineral and fibre board liner panels with 15 mm thick cover strips on one side • 2 layers of mineral and fibre board liner panels, base layer 25 mm and 15 mm secondary layer and 9.5 mm steel skin cementitious panels on other side 		
		3 h	-

NOTE: ULC Certification Bulletin No. 2003-08 (dated August 21, 2003) provides an official ULC permission for ULC listed and package labelled mineral fibre building insulation (processed from rock, slag and glass only) to be used in ULC non-load bearing wall assembly designs consisting of gypsum wallboard and steel or wood studs with a fire resistance rating not exceeding 2 hours when illustrated without insulation, without detracting from the rating assigned to the assembly.

Non-Load Bearing Chase Walls – Underwriters Laboratories of Canada

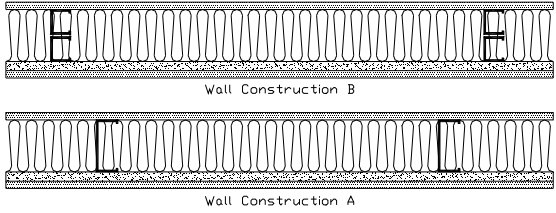
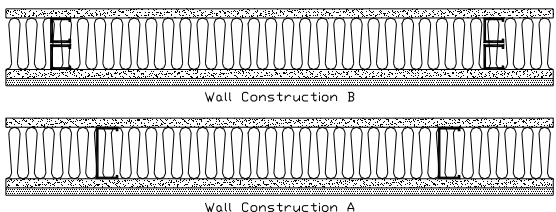
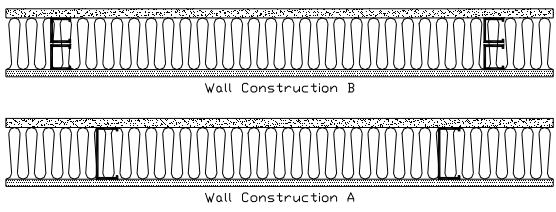
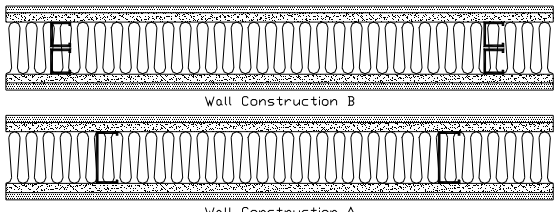
Source	Description	Fire Resistance Rating	Sound Transmission Class
ULC W436	<ul style="list-style-type: none"> • Wall B – pair of 41 mm x 32 mm x 0.66 mm thick steel studs spaced at 760 mm o.c. • 76 mm mineral wool insulation • 1 layer of 12.7 mm or 15.9 mm gypsum board on one side • 1 layer of 12.7 mm reinforced cement board, designated “Perma Base” on each side 		
		1 h	54* (Wall B, G 15.9mm)
ULC W437	<ul style="list-style-type: none"> • Wall B – pair of 41 mm x 32 mm x 0.66 mm thick steel studs spaced at 760 mm o.c. • 76 mm mineral wool insulation • 1 layer of 12.7 mm or 15.9 mm gypsum board on each side • 1 layer of 12.7 mm reinforced cement board, designated “Perma Base” on one side 		
		1 h	55* (Wall B, G 12.7mm) 57* (Wall B, G 15.9mm)
ULC W438	<ul style="list-style-type: none"> • Wall B – pair of 41 mm x 32 mm x 0.66 mm thick steel studs spaced at 760 mm o.c. • 76 mm mineral wool insulation • 1 layer of 15.9 mm gypsum board on one side • 1 layer of 12.7 mm reinforced cement board, designated “Perma Base” on other side 		
		1 h	55* (Wall B)
ULC W439	<ul style="list-style-type: none"> • Wall B pair of 41 mm x 32 mm x 0.66 mm thick steel studs spaced at 760 mm o.c. • 89 mm mineral wool insulation • 1 layer of 12.7 mm or 15.9 mm gypsum board on each side • 1 layer of 12.7 mm reinforced cement board, designated “Perma Base” on each side 		
		2 h	55* (Wall B, G 12.7mm) 57* (Wall B, G 15.9mm)

* Estimated value as per Warnock (2008)

Non-Load Bearing Chase Walls – Underwriters Laboratories of Canada

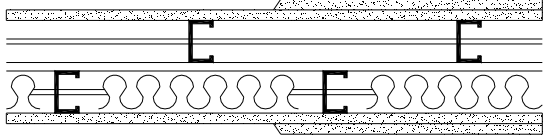
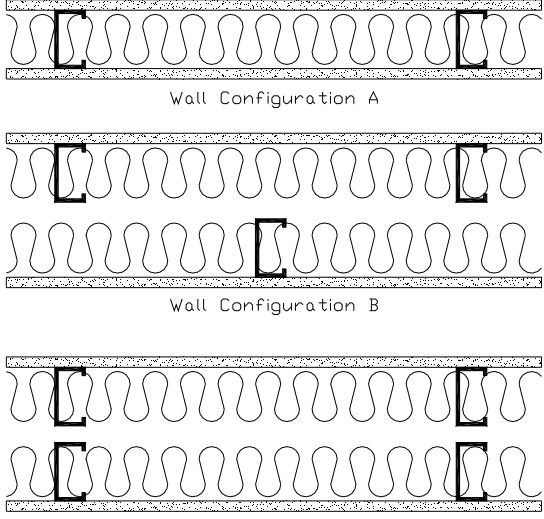
Source	Description	Fire Resistance Rating	Sound Transmission Class
ULC W454	<ul style="list-style-type: none"> 64 mm x 41 mm x 0.84 mm, for 1 hour, and 92 mm x 41 mm x 1.09 mm, for 2 hour, steel studs spaced at 406 mm o.c. 89 mm glass fibre insulation one one side of wall assembly 1 hour - 1 layer of 15.9 mm gypsum board on each side 2 hour - 2 layers of 15.9 mm gypsum board on each side 	 <p>1 h 2 h</p>	-
ULC W459	<ul style="list-style-type: none"> 89 mm x 38 mm x 0.56 mm steel stud spaced as follows: Configuration B: 203 mm or 305 mm o.c. Configuration C: 406 mm or 610 mm o.c. 89 mm glass fiber insulation with nom. density of 15 kg/m³ 1 layer of 15.9 mm “QuietRock” soundproof drywall on each side 	 <p>Wall Configuration A</p> <p>Wall Configuration B</p> <p>Wall Configuration C</p> <p>1 h</p>	-

Non-Load Bearing Chase Walls – Underwriters Laboratories of Canada

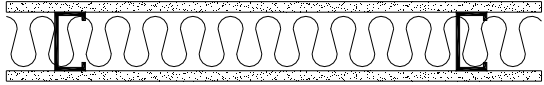
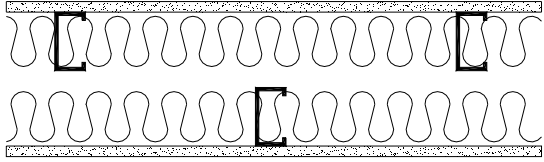
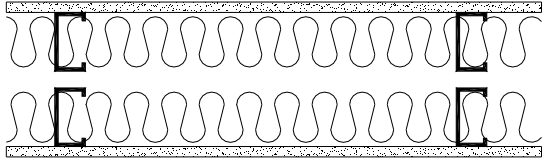
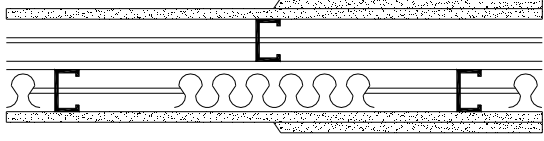
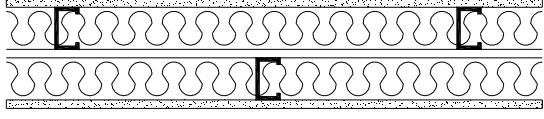
Source	Description	Fire Resistance Rating	Sound Transmission Class
ULC W460 	<ul style="list-style-type: none"> 89 mm x 30 mm x 0.37 mm proprietary steel stud (ClarkDietrich) spaced as follows: Configuration B: 203 mm or 305 mm o.c. Configuration C: 406 mm or 610 mm o.c. 89 mm glass fiber insulation with nom. density of 15 kg/m³ 1 layer of 15.9 mm “QuietRock” soundproof drywall on each side 	 Wall Configuration A	
		 Wall Configuration B	
		 Wall Configuration C	
		1 h	56* (Configuration B) 61* (Configuration C)
ULC W483	<ul style="list-style-type: none"> 63.5 mm x 41.3 mm x 0.627 mm steel studs spaced at 610 mm o.c. optional glass fibre insulation on one or both rows of studs 1 hour - 1 layer of 16 mm gypsum board on each side 2 hour - 2 layers of 16 mm gypsum board on each side 		
		1 h 2 h	-
ULC W486	<ul style="list-style-type: none"> 63.5 mm x 31.8 mm x 0.46 mm steel studs spaced at 610 mm o.c. 63 mm glass fibre insulation to fill both wall cavities 1 layer of 12.7 mm gypsum board on each side 		
		3/4 h	-

* Estimated value (see www.quietsolution.com/acousticfireassemblies.pdf)

NOTE: ULC Certification Bulletin No. 2003-08 (dated August 21, 2003) provides an official ULC permission for ULC listed and package labelled mineral fibre building insulation (processed from rock, slag and glass only) to be used in ULC non-load bearing wall assembly designs consisting of gypsum wallboard and steel or wood studs with a fire resistance rating not exceeding 2 hours when illustrated without insulation, without detracting from the rating assigned to the assembly.

Non-Load Bearing Area Separation Walls – Underwriters Laboratories of Canada

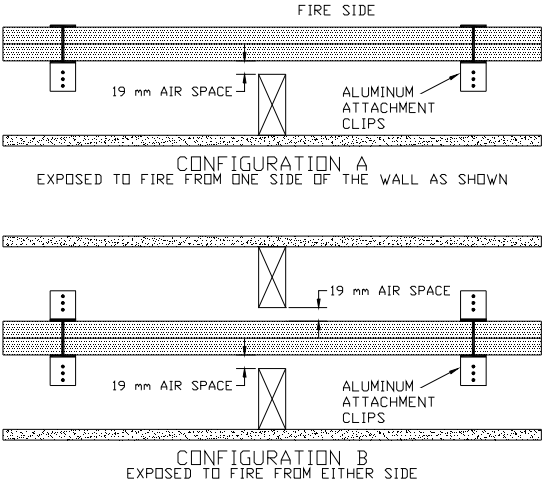
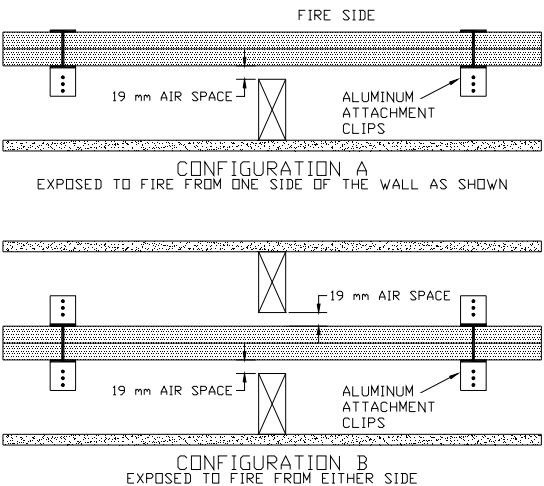
Source	Description	Fire Resistance Rating	Sound Transmission Class
ULC W311	Firewall (max. height – 13400 mm) <ul style="list-style-type: none"> • 51 mm x 35 mm x 0.53 mm thick “H” shaped steel studs spaced at 610 mm o.c. • 2 layers of 25.4 mm thick gypsum wallboard liner panels • 89 mm x 38 mm wood studs spaced at 610 mm o.c. • 1 layer 12.7 mm gypsum board • aluminum attachment clips 	 <p style="text-align: center;">2 h</p>	-
ULC W312	Firewall (max. height – 13400 mm) <ul style="list-style-type: none"> • 54 mm x 38 mm x 0.457 mm thick “H” shaped steel studs spaced at 610 mm o.c. • 2 layers of 25 mm thick gypsum wallboard liner panels • 89 mm x 38 mm wood studs spaced at 610 mm o.c. • 1 layer 12.7 mm gypsum board • aluminum attachment clips • optional glass fibre or mineral wool insulation 	 <p style="text-align: center;">2 h</p>	-

Non-Load Bearing Area Separation Walls – Underwriters Laboratories of Canada

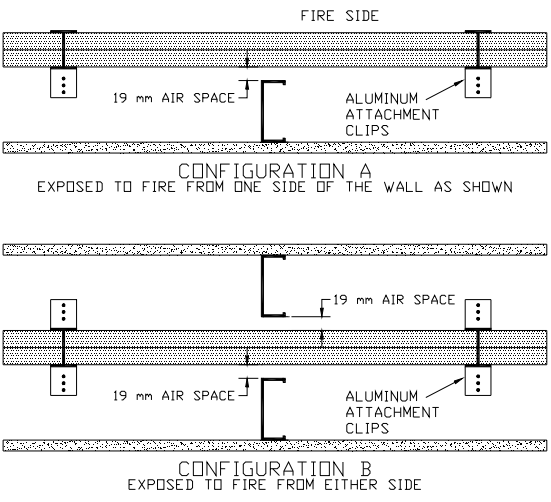
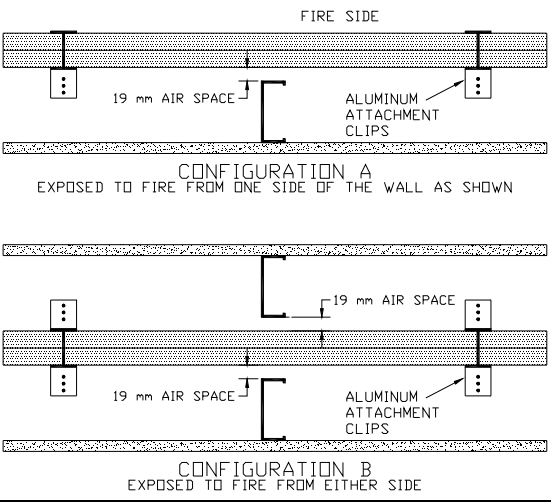
Source	Description	Fire Resistance Rating	Sound Transmission Class
ULC W314	Firewall (max. height – 13400 mm) <ul style="list-style-type: none"> • 51 mm x 35 mm x 0.46 mm thick “H” shaped steel studs spaced at 610 mm o.c. • 2 layers of 25.4 mm thick gypsum wallboard liner panels • 89 mm x 0.84 mm thick steel studs spaced at 610 mm o.c. for Bearing Wall Rating • 89 mm x 32 mm x 0.46 mm thick steel studs spaced at 610 mm o.c. for Nonbearing Wall Rating (Configuration B only) • 1 layer 12.7 mm gypsum board • aluminum attachment clips 	 <p style="text-align: center;">2 h</p>	-
ULC W320	Firewall (max. height – 13400 mm) <ul style="list-style-type: none"> • 51 mm x 35 mm x 0.53 mm thick “H” shaped steel studs spaced at 610 mm o.c. • 2 layers of 25.4 mm thick gypsum wallboard liner panels • 89 mm x 0.8 mm thick steel studs spaced at 610 mm o.c. for Bearing Wall Rating • 89 mm x 31.75 mm x 25 MSG mm thick steel studs spaced at 610 mm o.c. for Nonbearing Wall Rating (Configuration B only) • 1 layer 12.7 mm gypsum board • aluminum attachment clips 	 <p style="text-align: center;">2 h</p>	-

NOTE: ULC Certification Bulletin No. 2003-08 (dated August 21, 2003) provides an official ULC permission for ULC listed and package labelled mineral fibre building insulation (processed from rock, slag and glass only) to be used in ULC non-load bearing wall assembly designs consisting of gypsum wallboard and steel or wood studs with a fire resistance rating not exceeding 2 hours when illustrated without insulation, without detracting from the rating assigned to the assembly.

Non-Load Bearing Walls – National Research Council of Canada

The following page presents non-load bearing wall assemblies fire tested at NRCC during two multi industry (steel, wood, gypsum and insulation) fire testing programs that are reported on in two fire test reports, namely IR No. 674 (December 1994) and IR No. 675 (December 1994). The fire test report nos. appear in the source column and are followed by a “F” fire test no. used in the report. A relevant NRCC acoustic report is also listed below and this reference document deals with acoustic data, i.e., values of Sound Transmission Class that have been established as an estimated value or from an acoustic test where the acoustic test no. appears in the source column.

NRCC IR-674 data for F03 and F05 and IR-675 data for F07 to F11 (see page 80)

References (fire data):



Sultan, M.A., Lougheed, G.D., Denham, E.M.A., Monette, R.C. and MacLaurin, J.W., *Temperature Measurements in Full-Scale Fire Resistance Tests on Non-Insulated Regular Gypsum Board Wall Assemblies*, IRC Internal Report No. 674 (IR-674), National Research Council of Canada, Ottawa, Ontario, Canada, December 1994.

Sultan, M.A., MacLaurin, J.W., Denham, E.M.A. and Monette, R.C., *Temperature Measurements in Full-Scale Insulated and Non-Insulated (1x2) Gypsum Board Protected Wall Assemblies with Steel Studs*, IRC Internal Report No. 675 (IR-675), National Research Council of Canada, Ottawa, Ontario, Canada, December 1994.

Reference (acoustic data):

* Warnock, A.C.C., *Estimation of Sound Transmission Class and Impact Insulation Class Rating for Steel Framed Assemblies*, Report No. B3436.1 Revised, Institute for Research in Construction, National Research Council of Canada, Ottawa, Ontario, Canada, November 2008.

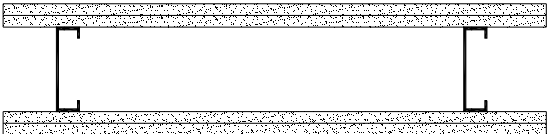
Non-Load Bearing Walls – National Research Council of Canada

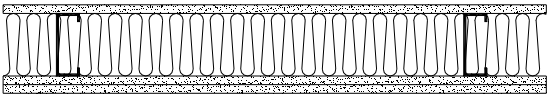
Source	Description	Fire Endurance	Sound Transmission Class
NRCC IR-674 F03 F05 USG840817	<ul style="list-style-type: none"> 90 mm x 30 mm x 0.46 mm thick steel studs spaced at 600 mm o.c. 2 layers 12.7 mm gypsum board on each side <p>NOTE: Density of gypsum board varies between two tests; F03=7.35kg/m² F05=7.80 kg/m²</p>		
		F03 = 63 min F05 = 69 min	50
NRCC IR-675 F07 TLA-02-013a	<ul style="list-style-type: none"> 90 mm x 30 mm x 0.46 mm thick steel studs spaced at 600 mm o.c. 1 layer 12.7 mm gypsum board on one side 2 layers 12.7 mm gypsum board on other side 		
		65 min	41
NRCC IR-675 F09 F10 F10B F11 a) NRC TL-92-411 b) TL-93-027	<ul style="list-style-type: none"> 90 mm x 30 mm x 0.46 mm thick steel studs spaced at 600 mm o.c. 1 layer 12.7 mm gypsum board on one side 2 layers 12.7 mm gypsum board on other side 90 mm thick insulation as follows: <p>F09 - glass fibre F10 - 584 mm wide mineral fibre F10B - 615 mm wide mineral fibre F11 – cellulose</p>		
		F09 = 65 min F10 = 60 min F10B = 100 min F11 = 62 min	52 ^a 52* 52* 53 ^b





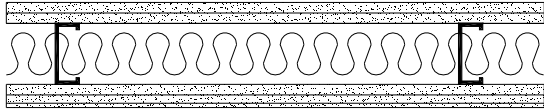
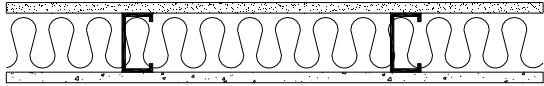
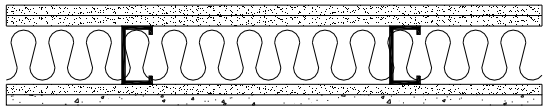
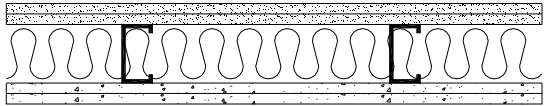

* Estimated value as per Warnock (2008)

Non-Load Bearing Walls – Underwriters Laboratories Inc.

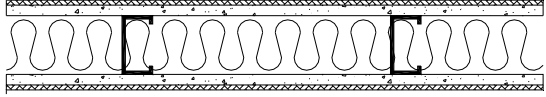
Source	Description	Fire Resistance Rating	Sound Transmission Class
UL U403 EQ	<ul style="list-style-type: none"> 3 $\frac{5}{8}$" x 1 $\frac{1}{4}$" x 25 gauge steel studs spaced at 24" o.c. optional mineral wool or glass fiber insulation 2 layers $\frac{5}{8}$" thick gypsum board on one side 1 layer $\frac{5}{8}$", 1 layer $\frac{1}{2}$" and 1 layer $\frac{1}{4}$" or $\frac{3}{8}$" thick gypsum board on other side 		
		2 h	58*
UL U404	<ul style="list-style-type: none"> 3 $\frac{1}{2}$" x 20 MSG steel studs spaced at 16" o.c. 3" mineral wool insulation 1 layer $\frac{1}{2}$" or $\frac{5}{8}$" cementitious board on one side 1 layer $\frac{5}{8}$" thick gypsum board on other side 		
		1 h	-
	<ul style="list-style-type: none"> 3 $\frac{1}{2}$" x 20 MSG steel studs spaced at 16" o.c. 3" mineral wool insulation 2 layers $\frac{5}{8}$" gypsum board on one side inner layer of $\frac{5}{8}$" thick gypsum, outer layer of $\frac{1}{2}$" or $\frac{5}{8}$" cementitious board on other side 	 <p style="text-align: center;">Configuration A</p>	
		2 h	-
	<ul style="list-style-type: none"> 3 $\frac{1}{2}$" x 20 MSG steel studs spaced at 16" o.c. 3" mineral wool insulation 2 layers $\frac{1}{2}$" or $\frac{5}{8}$" cementitious board on one side 2 layers $\frac{5}{8}$" thick gypsum board on other side 	 <p style="text-align: center;">Configuration B</p>	
		2 h	-

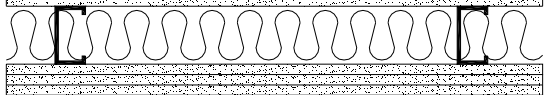
* Estimated value as per Warnock (2008)

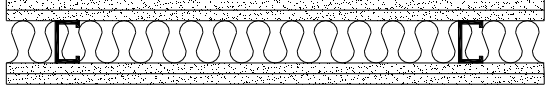
Non-Load Bearing Walls – Underwriters Laboratories Inc.

Source	Description	Fire Resistance Rating	Sound Transmission Class
UL U407  USG 840321	<ul style="list-style-type: none"> • 3 1/2" x 20 MSG steel studs spaced at 16" o.c. • 3" mineral wool insulation • 5/8" cementitious board, ceramic tiles and exterior finish on either side 		
		1 h	48
UL U408 	<ul style="list-style-type: none"> • 3 1/2" x 1 1/4" x 25 MSG steel studs spaced at 24" o.c. • optional glass fibre or mineral wool insulation • 1 layer 5/8" gypsum board on one side • 3 layers 5/8" gypsum board on other side 		
		2 h	-
UL U411  NRC TL-93-037	<ul style="list-style-type: none"> • 2 1/2" x 1 1/4" x 25 MSG steel studs spaced at 24" o.c. • optional mineral wool or glass fiber insulation • 2 layers 5/8" gypsum board on each side 		
		2 h	55 (GFB 2 1/2")
UL U412 	<ul style="list-style-type: none"> • 1 5/8" x 1 1/4" x 25 MSG steel studs spaced at 24" o.c. • optional glass fibre or mineral wool insulation • 2 layers 1/2" gypsum board on each side 		
		2 h	-

Non-Load Bearing Walls – Underwriters Laboratories Inc.

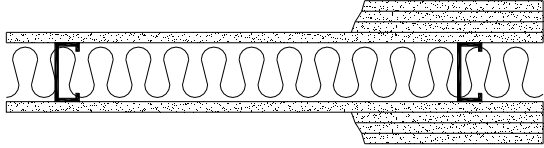
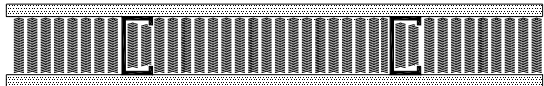
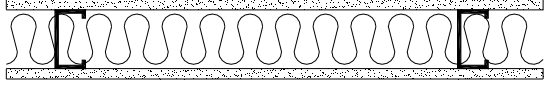
Source	Description	Fire Resistance Rating	Sound Transmission Class		
UL U419 EQ a) SA870717 b) SA860620 c) RAL-TL90-166 d) USG860808 e) USG910617 f) SA830112 g) SA830113 h) USG910907	<ul style="list-style-type: none"> min 25 MSG steel studs with 1 1/4" flanges, spaced at 24" o.c. mineral wool insulation optional except where required as noted by asterisk and described below stud depth, gypsum board layers, gypsum board thickness, and corresponding rating as shown <p>* 1 1/2" mineral wool insulation ** 3" mineral wool insulation *** 2" mineral wool insulation</p>				
		1 h	#Layer & Size 1-5/8	Stud Depth 3 1/2	49 ^a (RFB 3") 51 ^{b&c} (RFB 3 1/2") 40 ^d (NI) 50 ^e 59 ^f (RFB 1 1/2") 62 ^g (RFB 1 1/2") 56 ^h
		1 h	1-1/2	2 1/2 *	
		1 h	1-3/4	1 5/8	
		2 h	2-1/2	1 5/8	
		2 h	2-5/8	1 5/8	
		2 h	1-3/4	3 1/2 **	
		3 h	3-1/2	1 5/8	
		3 h	2-3/4	1 5/8	
		3 h	3-5/8	1 5/8	
		4 h	4-5/8	1 5/8	
		4 h	4-1/2	1 5/8	
		4 h	2-3/4	2 1/2 ***	
UL U431 EQ	<ul style="list-style-type: none"> 3 5/8" x 1 1/4" x 25 MSG steel studs spaced at 16" o.c. metal lath, diamond mesh, expanded steel 3.4 lbs per sq. yd. 3/4" thick plaster on each side spray-applied fire resistive material sprayed in stud cavity 				
		4 h		-	
UL U432	<ul style="list-style-type: none"> 3 1/2" x 20 MSG steel studs spaced at 24" o.c. optional glass fiber or mineral wool insulation 5/8" gypsum board on each side 				
		1 h		-	

Non-Load Bearing Walls – Underwriters Laboratories Inc.

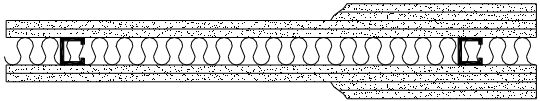
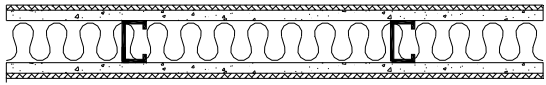
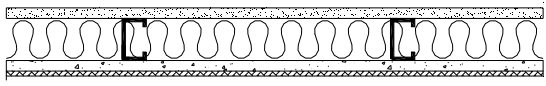
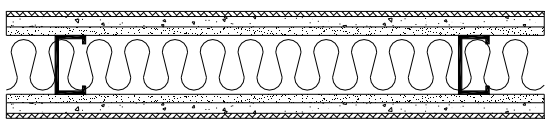
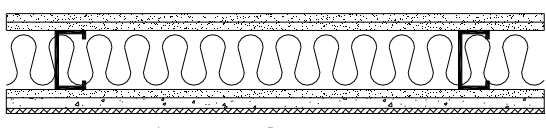
Source	Description	Fire Resistance Rating	Sound Transmission Class
UL U435  a) SA830112 b) SA830113	<ul style="list-style-type: none"> 1 5/8" x 1 1/4" x 25 MSG steel studs spaced at 16" or 24" o.c. optional mineral wool insulation 4 layers 1/2" gypsum board on each side for 4 h 3 layers 1/2" or 2 layers 3/4" gypsum board on each side for 3 h 		
		3 h 4 h	59 ^a (RFB 1 1/2") 62 ^b (RFB 1 1/2")
UL U442	<ul style="list-style-type: none"> 2 1/2" x 1 1/4" x 20 MSG steel studs spaced at 16" o.c. 2 1/2" mineral wool insulation 1/2" or 5/8" cementitious board and 1/4" ceramic tile on each side 		
	1 h	-	
	Alternate Construction <ul style="list-style-type: none"> 2 1/2" x 1 1/4" x 20 MSG steel studs spaced at 16" o.c. 2 1/2" mineral wool insulation 5/8" gypsum board on one side 1/2" or 5/8" cementitious board and 1/4" ceramic tile on other side 		
	1 h	-	
UL U443 SA851028	<ul style="list-style-type: none"> 3 5/8" x 1 1/4" x 20 MSG steel studs spaced at 24" o.c. 3" min "Thermafiber" insulation inner layer 1/2" gypsum board on each side 1 layer 1/2" or 5/8" cementitious board on each side outer layer 1/4" ceramic tile on each side 		
		 Alternate Construction	
		2 h *see UL listing for Alternate design	58 (CEMBRD 1/2")

Non-Load Bearing Walls – Underwriters Laboratories Inc.

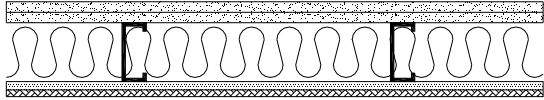
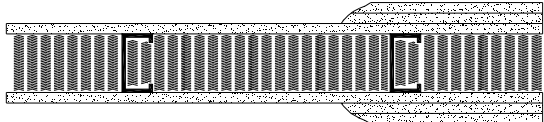
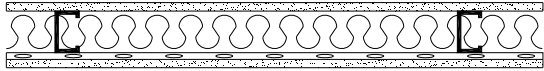
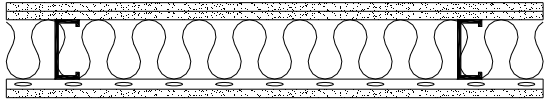
Source	Description	Fire Resistance Rating	Sound Transmission Class												
UL U449	<ul style="list-style-type: none"> 3 5/8" x 1 3/8" x 20 MSG steel studs spaced at 16" o.c. 3 5/8" insulation having min 3.5 pcf 2 layers 5/8" gypsum board on one side inner layer of 7/16" mineral and fiber board, and outer layer of ceramic tile on other side 		<p>1-1/2 h</p> <p><50*</p>												
UL U450 EQ	<ul style="list-style-type: none"> 2 1/2" x 1 1/4" x 25 MSG (1 h), 3 5/8" x 1 1/4" x 25 MSG (3 h) and 3 5/8" x 1 1/4" x 18 MSG (4 h) steel studs spaced at 16" o.c. spray-applied fire resistive material sprayed in stud cavity gypsum wallboard layers, wallboard thickness and corresponding rating as shown 		<table border="1"> <thead> <tr> <th></th> <th>#Layer & Size</th> <th></th> </tr> </thead> <tbody> <tr> <td>1 h</td> <td>1-5/8</td> <td>-</td> </tr> <tr> <td>3 h</td> <td>2-5/8</td> <td></td> </tr> <tr> <td>4 h</td> <td>3-5/8</td> <td></td> </tr> </tbody> </table>		#Layer & Size		1 h	1-5/8	-	3 h	2-5/8		4 h	3-5/8	
	#Layer & Size														
1 h	1-5/8	-													
3 h	2-5/8														
4 h	3-5/8														
UL U451 EQ	<ul style="list-style-type: none"> 2 1/2" x 1 1/4" x 25 MSG steel studs spaced at 24" o.c. 1 1/2" min "Thermafiber" insulation steel resilient channel, 25 MSG on one side spaced at 24" o.c. 1 layer of 1/2" or 5/8" gypsum board on each side 		<p>1 h</p> <p>-</p>												
UL U452 RAL-TL83-215	<ul style="list-style-type: none"> 3 1/2" x 1 1/4" x 20 MSG steel studs spaced at 24" o.c. 3" min "Thermafiber" insulation 2 layers 1/2" gypsum board on one side steel resilient channels, 25 ga, spaced at 24" o.c. 1 layer 1/2" gypsum board on other side 		<p>1-1/2 h</p> <p>58</p>												

* Estimated value as per Warnock (2008)

Non-Load Bearing Walls – Underwriters Laboratories Inc.

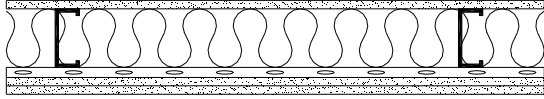
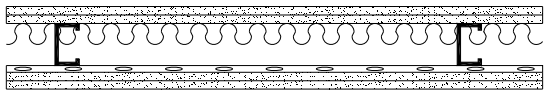
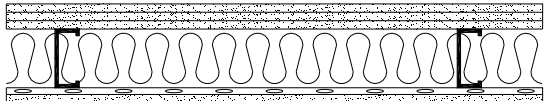
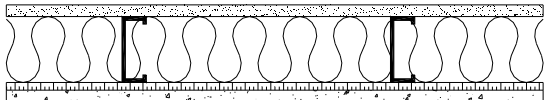

Source	Description	Fire Resistance Rating	Sound Transmission Class	
UL U453	<ul style="list-style-type: none"> • 3 1/2" x 1 1/4" x 20 MSG steel studs spaced at 24" o.c. • 3" min "Thermafiber" insulation • 1 layer of 1/2" gypsum board on one side • steel resilient channels, 25 ga, spaced at 24" o.c. • 2 layers of 1/2" gypsum board on other side 		2 h	-
UL U454 EQ	<ul style="list-style-type: none"> • 2 1/2" x 1 1/4" x 25 MSG steel studs spaced at 24" o.c. • 1" min "Thermafiber" mineral wool insulation • steel resilient channel, 25 MSG on one side spaced at 24" o.c. • 2 layers of 1/2" gypsum board on each side 		2 h	-
UL U455	<ul style="list-style-type: none"> • 3 1/2" x 1 1/4" x 20 MSG steel studs spaced at 24" o.c. • 3" min "Thermafiber" insulation • 3 layers of 1/2" gypsum board on one side • steel resilient channels, 25 MSG spaced at 24" o.c. • 2 layers of 1/2" gypsum board on other side 		3 h	-
UL U457 USG840222	<ul style="list-style-type: none"> • 3 5/8" x 1 1/4" x 20 MSG steel studs spaced at 16" o.c. • 1 layer 5/8" gypsum board on one side • 3" min "Thermafiber" insulation • inner layer of 1/2" rigid polystyrene insulation (optional), and outer layer of 1/2" or 5/8" cementitious board on other side 		1 h	50 (CEMBRD 1/2")

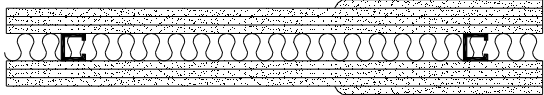
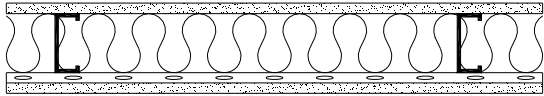
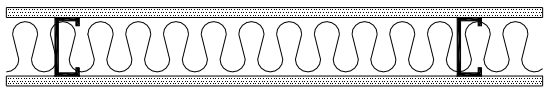
Non-Load Bearing Walls – Underwriters Laboratories Inc.

Source	Description	Fire Resistance Rating	Sound Transmission Class
UL U463 EQ	<ul style="list-style-type: none"> 1 5/8" x 1 1/4" x 25 MSG steel studs spaced at 16" or 24" o.c. optional 1 1/2" thick batts and blankets or spray applied cellulose insulation 4 layers 1/2" gypsum board on each side for 4 h 3 layers 1/2" gypsum board on each side for 3 h 		
		3 h 4 h	-
UL U465 EQ a) SA870717 b) SA860620 c) RAL-TL90-166	<ul style="list-style-type: none"> 3 5/8" x 1 1/4" x 25 MSG steel studs spaced at 24" o.c. optional mineral wool or glass fiber insulation optional steel resilient channels, 25ga, spaced at 24" o.c. 1 layer 5/8" gypsum board on each side 		
		1 h	49 ^a (RFB 3") 51 ^{b & c} (RFB 3 1/2") 51* (RFB 3 1/2" RC)
UL U471 EQ	<ul style="list-style-type: none"> 3 5/8" x 1 1/4" x 25 MSG steel studs spaced at 24" o.c. 3 1/4" min mineral wool batt insulation having min 4 pcf or spray applied cellulose insulation 1 layer 0.591" mineral and fiber board, designated "Promat-H" on each side 		
		1-1/2 h	-

* Estimated value as per Warnock (2008)

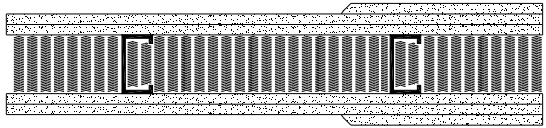
Non-Load Bearing Walls – Underwriters Laboratories Inc.

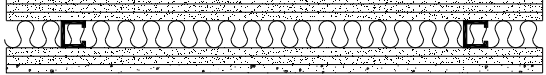
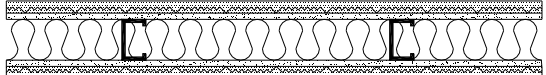
Source	Description	Fire Resistance Rating	Sound Transmission Class															
UL U475 	<ul style="list-style-type: none"> min 25 MSG (1, 2 and 3 h), and 18 MSG (4 h) steel studs with x 1 1/4" legs, spaced at 16" o.c. metal lath, diamond mesh, expanded steel 3.4 lbs per sq. yd. stud depth, min thickness of material applied to metal lath, and corresponding rating as shown cementitious mixture, spray-applied fire resistive material sprayed or vermiculate concrete in stud cavity 2 layers 5/8" gypsum board on each side for 1, 2 and 3 h and 3 layers 5/8" gypsum board on each side for 4 h 																	
		<table border="1"> <thead> <tr> <th></th> <th>Cavity Material</th> <th>Stud Depth</th> <th></th> </tr> </thead> <tbody> <tr> <td>1 h</td> <td>2</td> <td>2-1/2</td> <td rowspan="4" style="text-align: center;">-</td> </tr> <tr> <td>2 h</td> <td>2-3/4</td> <td>3-1/4</td> </tr> <tr> <td>3 h</td> <td>3-1/4</td> <td>3-5/8</td> </tr> <tr> <td>4 h</td> <td>4</td> <td>4</td> </tr> </tbody> </table>		Cavity Material	Stud Depth		1 h	2	2-1/2	-	2 h	2-3/4	3-1/4	3 h	3-1/4	3-5/8	4 h	4
	Cavity Material	Stud Depth																
1 h	2	2-1/2	-															
2 h	2-3/4	3-1/4																
3 h	3-1/4	3-5/8																
4 h	4	4																
UL U478 	<ul style="list-style-type: none"> 1 5/8" x 1 1/4" x 25 MSG steel studs spaced at 24" o.c. optional mineral wool or spray applied cellulose insulation filling stud cavity 3 layers 1/2" gypsum board on one side inner 2 layers 1/2" thick gypsum board and outer layer 1/2" or 5/8" cementitious board on other side 																	
		3 h	-															
UL U484	<ul style="list-style-type: none"> 2 1/2" x 1 1/4" x 20 MSG steel stud spaced at 16" o.c. optional "Thermafiber" insulation 1 layer 3/8" gypsum board on each side metal lath and 3/4" plaster on each side 																	
		2 h	<50*															

* Estimated value as per Warnock (2008)

Non-Load Bearing Walls – Underwriters Laboratories Inc.

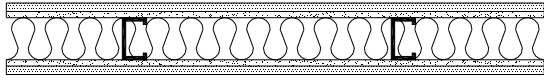
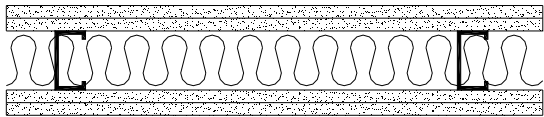
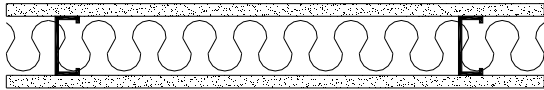
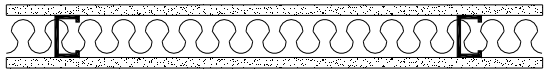
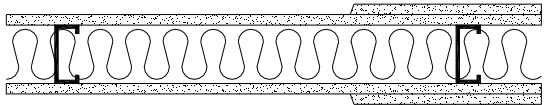
Source	Description	Fire Resistance Rating	Sound Transmission Class
UL U488	<ul style="list-style-type: none"> 2 ½" x 1¼" x 20 MSG steel stud spaced at 16" o.c. 1" min. "Thermafiber" insulation 1 layer ⅜" gypsum board on each side 7/16" plaster on each side 		
		1 h	<50*
UL U490 EQ USG910907	<ul style="list-style-type: none"> 2 ½" x 1¼" x 25 MSG steel stud spaced at 24" o.c. 2" nominal "Thermafiber" insulation 2 layers ¾" gypsum board on each side 		
		4 h	56
UL U491 EQ USG910617	<ul style="list-style-type: none"> 3 ½" x 1¼" x 25 MSG steel stud spaced at 24" o.c. 3" nominal "Thermafiber" insulation 1 layer ¾" gypsum board on each side 		
		2 h	50
UL U494 EQ	<ul style="list-style-type: none"> 2 ½" x 1¼" x 25 MSG steel stud spaced at 16" or 24" o.c. 2 ½" glass fiber batts 1 layer ⅝" gypsum board on each side 		
		1 h	-
UL U495 EQ a) SA860620 b) RAL-TL90-166	<ul style="list-style-type: none"> 3 ⅝" x 1¼" x 25 MSG steel studs spaced at 24" o.c. optional mineral wool or glass fiber insulation 1 hour - 1 layer ⅝" or ¾" gypsum board on each side 2 hour – 2 layers ⅝" gypsum board on each side 		
		1 h	51 ^{a&b} (G ⅝" RFB 3½")
		2 h	53* (G ¾" RFB 3½") 58* (RFB 3½")





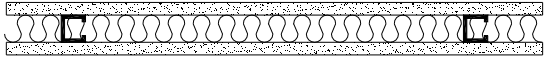
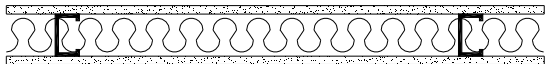
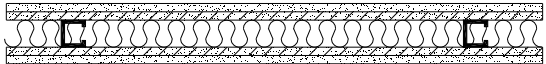
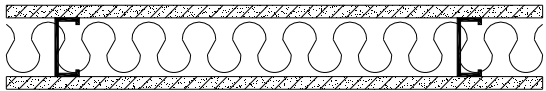
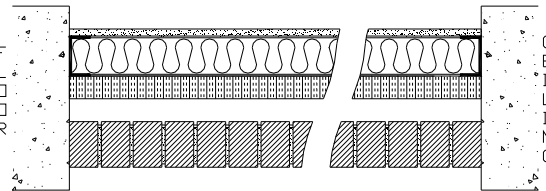

* Estimated value as per Warnock (2008)

Non-Load Bearing Walls – Underwriters Laboratories Inc.

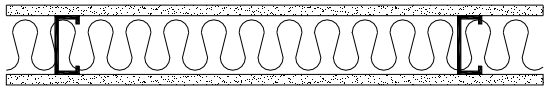
Source	Description	Fire Resistance Rating	Sound Transmission Class
UL U496 EQ	<ul style="list-style-type: none"> 1 5/8" x 1 1/4" x 25 MSG steel studs spaced at 24" o.c. optional mineral wool batts filling stud cavity 3/4" gypsum board on each side 		
		1 h	-
UL V401	<ul style="list-style-type: none"> 2 1/2" x 1 3/8" x 25 ga steel stud spaced at 24" o.c. 2" mineral wool insulation with UL Classification Marking 1 layer 1/2" gypsum board on each side 		
		1 h	47*
UL V410 EQ	<ul style="list-style-type: none"> 1 5/8" x 1 1/4" x 25 MSG steel studs spaced at 24" o.c. optional mineral wool or glass fiber batts filling stud cavity 1/2" "building unit" gypsum board on each side 1/2" gypsum board on each side 		
		2 h	-
UL V412 EQ	<ul style="list-style-type: none"> 3 1/2" x 1 1/4" x 25 MSG steel stud spaced at 24" o.c. 3" nominal mineral wool batts 3/4" "building unit" gypsum board on each side 		
		2 h	-
UL V414	<ul style="list-style-type: none"> 3 5/8" x 1 5/8" x 20 MSG steel studs spaced at 16" o.c. 3 1/2" glass fiber insulation 1 layer 5/8" gypsum board on one side 1 layer 2" foamed plastic board on other side 4" brick veneer 		
		3 h Interior 1 h Exterior	-

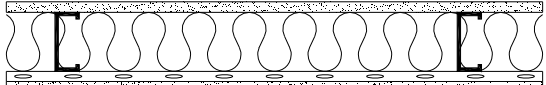
* Estimated value as per Warnock (2008)

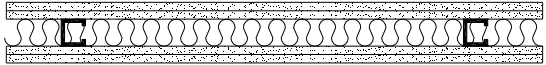
Non-Load Bearing Walls – Underwriters Laboratories Inc.

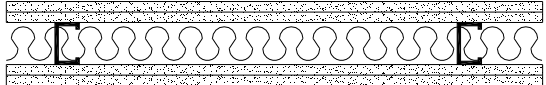
Source	Description	Fire Resistance Rating	Sound Transmission Class
UL V416  USG860808	<ul style="list-style-type: none"> • 3 5/8" x 1 1/4" x 25 MSG steel studs spaced at 24" o.c. • optional mineral wool or glass fiber insulation • 1 layer 5/8" or 3/4" gypsum board on each side 		
		1 h	40 (G 5/8" NI) 43* (G 3/4" NI) 53* (G 3/4" RFB 3/2")
UL V417 	<ul style="list-style-type: none"> • 3 5/8" x 1 1/4" x 25 MSG steel studs spaced at 24" o.c. • mineral wool batts filling stud cavity • optional steel resilient channels, 25 MSG, spaced at 24" o.c. • 1 layer 5/8" gypsum board on each side 		
		1 h	-
UL V418 	<ul style="list-style-type: none"> • 1 5/8" x 1 1/4" x 25 MSG steel studs spaced at 24" o.c. • mineral wool batts filling stud cavity • 2 layers 1/2" gypsum board on each side 		
		2 h	-
UL V419 	<ul style="list-style-type: none"> • 2 1/2" x 1 1/4" x 25 MSG steel stud spaced at 24" o.c. • mineral wool batts filling stud cavity • 2 layers 5/8" gypsum board on each side 		
		2 h	-

* Estimated value as per Warnock (2008)



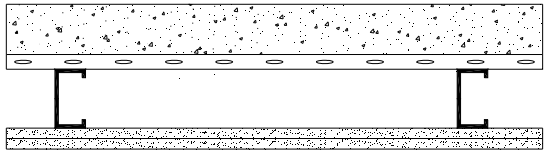
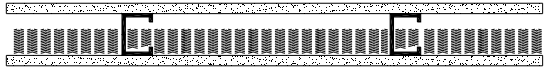
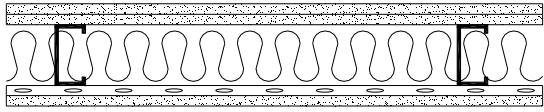

Non-Load Bearing Walls – Underwriters Laboratories Inc.

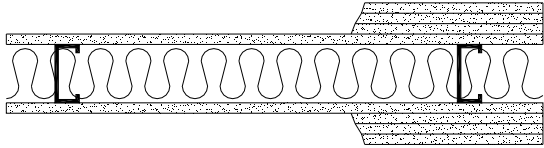
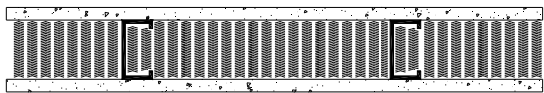
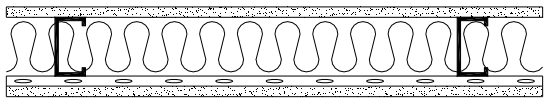
Source	Description	Fire Resistance Rating	Sound Transmission Class
UL V420	<ul style="list-style-type: none"> • 3 1/2" x 20 MSG steel stud spaced at 24" o.c. • min 3" thick and max 2' wide precast autoclaved aerated concrete panels on one side • 7/8" furring channels spaced 24" o.c. on one side • 2 layers of 5/8" gypsum board on other side 		
UL V425 EQ	<ul style="list-style-type: none"> • 2 1/2" x 1 1/4" x 25 MSG steel studs spaced at 16" o.c. • 1 1/2" spray-applied fire resistive material sprayed in stud cavity • 1 layer 5/8" gypsum board on each side 		
UL V435 EQ	<ul style="list-style-type: none"> • 3 5/8" x 1 1/4" x 25 MSG steel studs spaced at 24" o.c. • mineral wool batts filling stud cavity with min. 2.5 pcf density • steel resilient channels, 25 MSG, spaced at 24" o.c. on one side • 1 layer 5/8" gypsum board on one side • 2 layers of 5/8" gypsum board on other side 		
		2 h	-
		1 h	-
		1 h	52

Non-Load Bearing Walls – Underwriters Laboratories Inc.

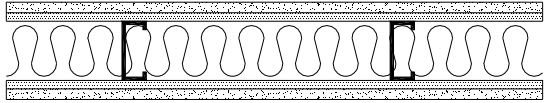
Source	Description	Fire Resistance Rating	Sound Transmission Class		
UL V438 EQ	<ul style="list-style-type: none"> min 25 MSG steel studs with 1¼” flanges, spaced at 24” o.c. mineral wool insulation optional except where required as noted by asterisk and described below stud depth, gypsum board layers, gypsum board thickness, and corresponding rating as shown <p>* 2” mineral wool insulation</p>				
			#Layer & Size	Stud Depth	-
		1 h	1-5/8	3 5/8	
		1 h	1-1/2	2 1/2*	
		2 h	2-1/2	1 5/8	
		2 h	2-5/8	2 1/2	
		3 h	3-1/2	1 5/8	
		3 h	3-5/8	1 5/8	
		4 h	4-1/2	1 5/8	
		4 h	4-5/8	1 5/8	
UL V443 EQ	<ul style="list-style-type: none"> 3 5/8” x 1 1/4” x 25 MSG steel studs spaced at 16” o.c. metal lath, diamond mesh, expanded steel 3.4 lbs per sq. yd. vermiculate concrete pumped into stud cavity 3/4” plaster (sand & unfibered gypsum) on one side 3/4” portland cement plaster (cement, lime & sand) on other side 				
		4 h	-		
UL V444 EQ	<ul style="list-style-type: none"> 3 5/8” x 1 1/4” x 25 MSG steel studs spaced at 24” o.c. optional mineral wool or glass fiber batts optional steel resilient channels, 25 MSG, spaced at 24” o.c. 1 layer 5/8” gypsum board on each side non-metallic plumbing system components in stud cavity attached to horizontal cross bracing (steel or lumber) 				
		1 h	-		

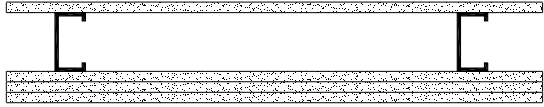
Non-Load Bearing Walls – Underwriters Laboratories Inc.

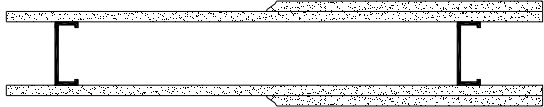
Source	Description	Fire Resistance Rating	Sound Transmission Class
UL V448 	<ul style="list-style-type: none"> • 3 5/8" x 1 1/4" x 25 MSG steel studs spaced at 16" o.c. • nom. 3" mineral wool batts, min. 3.4 pcf, friction fit • inner layer 1/2" mineral and fiber board designated "Homasote Type 440-32" on each side • outer layer 5/8" gypsum board on each side 		
		1 h	-
UL V449 	<ul style="list-style-type: none"> • 3 1/2" x 1 1/4" x 25 MSG steel studs spaced at 24" o.c. • 1 layer 5/8" gypsum board on one side • 3 layers 5/8" gypsum board on other side 		
		2 h	-
UL V450  RAL-TL05-078	<ul style="list-style-type: none"> • 3 5/8" (1 hour), 2 1/2" (2 or 2 1/2 hour) and 1 5/8" (2 hour) proprietary steel stud (ClarkDietrich) with 0.0150" thickness spaced at 24" o.c. • 1 hour - 1 layer of 5/8" gypsum board on each side • 2 and 2 1/2 hour – 2 layers of 5/8" gypsum board on each side • optional glass fiber or mineral wool insulation friction fit in stud cavities • optional steel resilient channel, 25 MSG on one side spaced at 24" o.c. 		
		1 h	39 (NI) 48 (GFB 3 5/8")
		2 h 2 1/2 h	52 (GFB 3 5/8" RC) 61 (GFB 3 5/8" RC) -

Non-Load Bearing Walls – Underwriters Laboratories Inc.

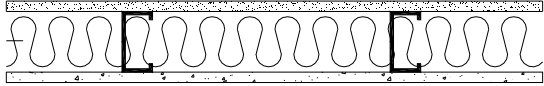
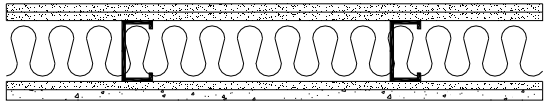
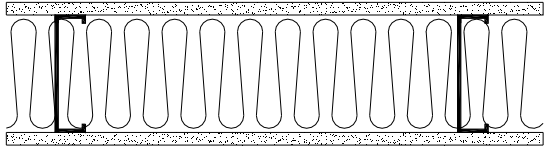
Source	Description	Fire Resistance Rating	Sound Transmission Class
UL V452 	<ul style="list-style-type: none"> • 3 5/8" x 1 1/4" x 25 MSG steel studs spaced at 16" o.c. • nom. 3" mineral wool batts, min. 2.6 pcf, friction fit • 1 layer 1/2", 5/8", 3/4 or 1" cementitious backer units on one side • 1 layer 5/8" thick gypsum board on other side 	 1 h	-
	<ul style="list-style-type: none"> • 3 5/8" x 1 1/4" x 25 MSG steel studs spaced at 16" o.c. • nom. 3" mineral wool batts, min. 2.6 pcf, friction fit • 2 layers 1/2" gypsum board on one side • inner layer of 1/2" thick gypsum, outer layer of 1/2", 5/8", 3/4 or 1" cementitious backer units on other side 	 2 h	-
UL V453	<ul style="list-style-type: none"> • 6" x 1 1/4" x 20 MSG steel studs spaced at 24" o.c. • 6 1/4" glass fibre insulation • 1 layer 3/4" thick gypsum board on each side 	 1 1/2 h	-

Non-Load Bearing Walls – Underwriters Laboratories Inc.

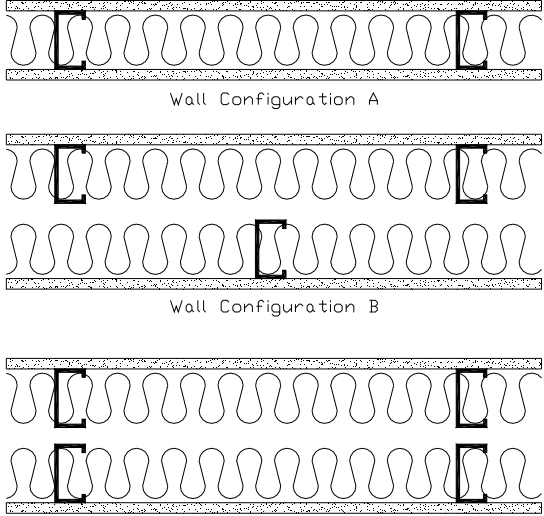
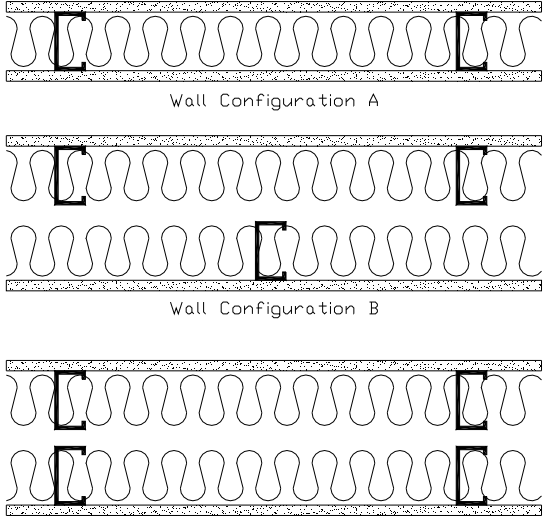
Source	Description	Fire Resistance Rating	Sound Transmission Class
<p>UL V463</p>	<ul style="list-style-type: none"> • 3 1/2" x 1 1/2" x 25 MSG steel stud spaced as follows: Configuration A: 16" or 24" o.c. • 3 1/2" glass fiber insulation with nom. density of 0.95 pcf • 1 layer of 5/8" "QuietRock" soundproof drywall on each side 	 <p>Wall Configuration A</p> <p>Wall Configuration B</p> <p>Wall Configuration C</p>	<p>1 h</p> <p>-</p>
<p>UL V464</p> <p>RAL TL07-069</p> <p>EQ</p>	<ul style="list-style-type: none"> • 3 5/8" proprietary steel stud (ClarkDietrich) with 0.0150" thickness and spaced as follows: Configuration A: 16" or 24" o.c. • 3 1/2" glass fiber insulation with nom. density of 0.95 pcf • 1 layer of 5/8" "QuietRock" soundproof drywall on one side and 1 layer of 5/8" Type X gypsum board on other side 	 <p>Wall Configuration A</p> <p>Wall Configuration B</p> <p>Wall Configuration C</p>	<p>1 h</p> <p>55 (Configuration A)</p>

Non-Load Bearing Walls – Underwriters Laboratories Inc.

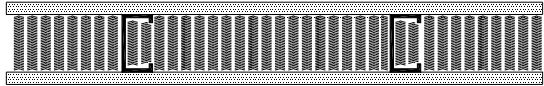
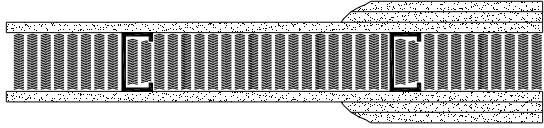
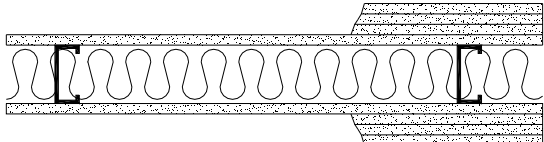
Source	Description	Fire Resistance Rating	Sound Transmission Class																																																				
UL V475	<ul style="list-style-type: none"> 3 $\frac{5}{8}$" x 1 $\frac{1}{4}$" x 25 MSG steel studs spaced at 16" o.c. metal lath, diamond mesh, expanded steel 3.4 lbs per sq. yd. $\frac{3}{4}$" thick plaster on each side spray-applied fire resistive material sprayed in stud cavity 																																																						
		4 h	-																																																				
UL V476 EQ	<ul style="list-style-type: none"> min 25 MSG (1, and 3 h), and min 18 MSG (4 h) steel studs with 1 $\frac{1}{4}$" legs, spaced at 16" o.c. metal lath, diamond mesh, expanded steel 3.4 lbs per sq. yd. stud depth, gypsum board layers, gypsum board thickness and corresponding rating as shown spray-applied fire resistive material sprayed in stud cavity 																																																						
		<table border="1"> <thead> <tr> <th></th> <th># Layer & Size</th> <th>Stud Depth</th> <th></th> </tr> </thead> <tbody> <tr> <td>1 h</td> <td>1 - $\frac{5}{8}$</td> <td>3$\frac{5}{8}$ or 2$\frac{1}{2}$</td> <td style="text-align: center;">-</td> </tr> <tr> <td>3 h</td> <td>2 - $\frac{5}{8}$</td> <td>3$\frac{5}{8}$</td> <td></td> </tr> <tr> <td>4 h</td> <td>3 - $\frac{5}{8}$</td> <td>3$\frac{5}{8}$</td> <td></td> </tr> </tbody> </table>		# Layer & Size	Stud Depth		1 h	1 - $\frac{5}{8}$	3 $\frac{5}{8}$ or 2 $\frac{1}{2}$	-	3 h	2 - $\frac{5}{8}$	3 $\frac{5}{8}$		4 h	3 - $\frac{5}{8}$	3 $\frac{5}{8}$		-																																				
			# Layer & Size	Stud Depth																																																			
1 h	1 - $\frac{5}{8}$	3 $\frac{5}{8}$ or 2 $\frac{1}{2}$	-																																																				
3 h	2 - $\frac{5}{8}$	3 $\frac{5}{8}$																																																					
4 h	3 - $\frac{5}{8}$	3 $\frac{5}{8}$																																																					
UL V477 EQ	<ul style="list-style-type: none"> min 25 MSG steel studs with 1$\frac{1}{4}$" flanges, spaced at 24" o.c. mineral wool batts friction fitted between studs, optional except where required as noted by asterisk and described below stud depth, drywall layers, drywall thickness, and corresponding rating as shown <p>* 1$\frac{1}{2}$" mineral wool batts ** 3" mineral wool batts *** 2" mineral wool batts</p>																																																						
		<table border="1"> <thead> <tr> <th></th> <th>Stud Depth</th> <th># Layer & Size</th> <th></th> </tr> </thead> <tbody> <tr> <td>1 h</td> <td>3$\frac{1}{2}$</td> <td>1 - $\frac{5}{8}$</td> <td style="text-align: center;">-</td> </tr> <tr> <td>1 h</td> <td>2$\frac{1}{2}$</td> <td>1 - $\frac{1}{2}$ *</td> <td></td> </tr> <tr> <td>1 h</td> <td>1$\frac{5}{8}$</td> <td>1 - $\frac{3}{4}$</td> <td></td> </tr> <tr> <td>2 h</td> <td>1$\frac{5}{8}$</td> <td>2 - $\frac{1}{2}$</td> <td></td> </tr> <tr> <td>2 h</td> <td>1$\frac{5}{8}$</td> <td>2 - $\frac{5}{8}$</td> <td></td> </tr> <tr> <td>2 h</td> <td>3$\frac{1}{2}$</td> <td>1 - $\frac{3}{4}$ **</td> <td></td> </tr> <tr> <td>3 h</td> <td>1$\frac{5}{8}$</td> <td>3 - $\frac{1}{2}$</td> <td></td> </tr> <tr> <td>3 h</td> <td>1$\frac{5}{8}$</td> <td>2 - $\frac{3}{4}$</td> <td></td> </tr> <tr> <td>3 h</td> <td>1$\frac{5}{8}$</td> <td>3 - $\frac{5}{8}$</td> <td></td> </tr> <tr> <td>4 h</td> <td>1$\frac{5}{8}$</td> <td>4 - $\frac{5}{8}$</td> <td></td> </tr> <tr> <td>4 h</td> <td>1$\frac{5}{8}$</td> <td>4 - $\frac{1}{2}$</td> <td></td> </tr> <tr> <td>4 h</td> <td>2$\frac{1}{2}$</td> <td>2 - $\frac{3}{4}$ ***</td> <td></td> </tr> </tbody> </table>		Stud Depth	# Layer & Size		1 h	3 $\frac{1}{2}$	1 - $\frac{5}{8}$	-	1 h	2 $\frac{1}{2}$	1 - $\frac{1}{2}$ *		1 h	1 $\frac{5}{8}$	1 - $\frac{3}{4}$		2 h	1 $\frac{5}{8}$	2 - $\frac{1}{2}$		2 h	1 $\frac{5}{8}$	2 - $\frac{5}{8}$		2 h	3 $\frac{1}{2}$	1 - $\frac{3}{4}$ **		3 h	1 $\frac{5}{8}$	3 - $\frac{1}{2}$		3 h	1 $\frac{5}{8}$	2 - $\frac{3}{4}$		3 h	1 $\frac{5}{8}$	3 - $\frac{5}{8}$		4 h	1 $\frac{5}{8}$	4 - $\frac{5}{8}$		4 h	1 $\frac{5}{8}$	4 - $\frac{1}{2}$		4 h	2 $\frac{1}{2}$	2 - $\frac{3}{4}$ ***		-
			Stud Depth	# Layer & Size																																																			
		1 h	3 $\frac{1}{2}$	1 - $\frac{5}{8}$	-																																																		
		1 h	2 $\frac{1}{2}$	1 - $\frac{1}{2}$ *																																																			
		1 h	1 $\frac{5}{8}$	1 - $\frac{3}{4}$																																																			
		2 h	1 $\frac{5}{8}$	2 - $\frac{1}{2}$																																																			
		2 h	1 $\frac{5}{8}$	2 - $\frac{5}{8}$																																																			
		2 h	3 $\frac{1}{2}$	1 - $\frac{3}{4}$ **																																																			
		3 h	1 $\frac{5}{8}$	3 - $\frac{1}{2}$																																																			
		3 h	1 $\frac{5}{8}$	2 - $\frac{3}{4}$																																																			
		3 h	1 $\frac{5}{8}$	3 - $\frac{5}{8}$																																																			
		4 h	1 $\frac{5}{8}$	4 - $\frac{5}{8}$																																																			
4 h	1 $\frac{5}{8}$	4 - $\frac{1}{2}$																																																					
4 h	2 $\frac{1}{2}$	2 - $\frac{3}{4}$ ***																																																					

Non-Load Bearing Walls – Underwriters Laboratories Inc.

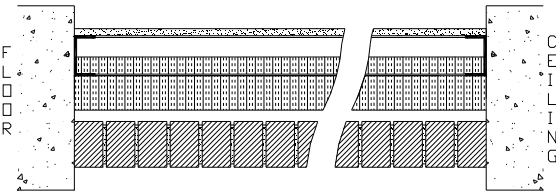
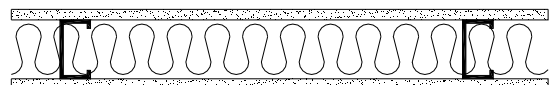
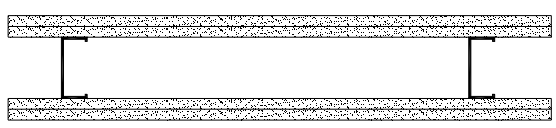
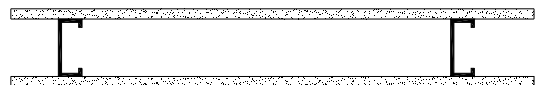
Source	Description	Fire Resistance Rating	Sound Transmission Class
UL V482	<ul style="list-style-type: none"> • 3⁵/₈" x 1¹/₂" x 18 MSG steel stud spaced at 16" o.c. • 1¹/₂" max. spray-applied polyurethane foam plastic in steel cavity • 1 layer 5⁸/₈" gypsum board on one side • 1 layer 1¹/₂" to 3" foamed plastic board on other side • 4" brick veneer 	 <p>1 h</p>	-
UL V483	<ul style="list-style-type: none"> • 3 1¹/₂" x 1¹/₂" x 25 MSG steel stud spaced at 24" o.c. • 3" mineral wool insulation • 5⁸/₈" Type X gypsum board on one side • 5⁸/₈" "SoundBreak" gypsum board on other side 	 <p>1 h</p>	-
UL V484	<ul style="list-style-type: none"> • 3 1¹/₂" x 1¹/₂" x 25 MSG steel stud spaced at 24" o.c. • 3" mineral wool insulation • two 5⁸/₈" gypsum board on each side 	 <p>2 h</p>	-
UL V485 EQ	<ul style="list-style-type: none"> • 3 5⁸/₈" x 1¹/₄" x 0.0156" steel stud spaced at 24" o.c. • optional glass fibre or mineral wool insulation • one layer 5⁸/₈" gypsum board on each side 	 <p>1 h</p>	-

Non-Load Bearing Walls – Underwriters Laboratories Inc.

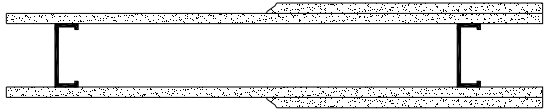
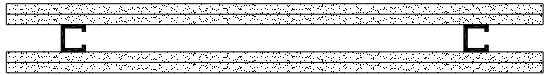
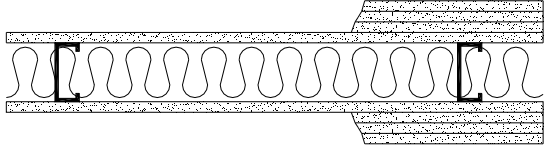
Source	Description	Fire Resistance Rating	Sound Transmission Class																													
UL V486 EQ	<ul style="list-style-type: none"> 3 5/8" (1 hour), 2 1/2" (2 or 2 1/2 hour) and 1 5/8" (2 hour) steel studs spaced at 24" o.c. 1 hour - 1 layer of 5/8" gypsum board on each side 2 and 2 1/2 hour – 2 layers of 5/8" gypsum board on each side optional glass fiber or mineral wool insulation friction fit in stud cavities optional resilient furring channels, 25 MSG spaced at 24" o.c. 	 1 h 2 h 2 1/2 h	-																													
UL V487 EQ	<ul style="list-style-type: none"> 1 5/8" x 1 3/16" x 25 MSG steel stud spaced at 24" o.c. 2 layers of 5/8" gypsum board on each side 	 2 h	-																													
UL V489 EQ	<ul style="list-style-type: none"> min 25 MSG steel studs with 1 1/4" flanges, spaced at 24" o.c. mineral wool insulation optional except where required as noted by asterisk and described below stud depth, gypsum board layers, gypsum board thickness, and corresponding rating as shown <p>* 3 1/2" mineral wool insulation</p> <p>** 1 1/2" mineral wool insulation</p>	 <table border="1" data-bbox="906 1255 1320 1621"> <thead> <tr> <th></th> <th>#Layer & Size</th> <th>Stud Depth</th> <th></th> </tr> </thead> <tbody> <tr> <td>1 h</td> <td>1-5/8</td> <td>3 5/8 *</td> <td rowspan="12">-</td> </tr> <tr> <td>1 h</td> <td>1-1/2</td> <td>2 1/2 or 3 5/8 **</td> </tr> <tr> <td>2 h</td> <td>2-1/2</td> <td>1 5/8 or 3 5/8</td> </tr> <tr> <td>2 h</td> <td>2-5/8</td> <td>1 5/8 or 3 5/8</td> </tr> <tr> <td>3 h</td> <td>3-1/2</td> <td>1 5/8 or 3 5/8</td> </tr> <tr> <td>3 h</td> <td>3-5/8</td> <td>1 5/8 or 3 5/8</td> </tr> <tr> <td>4 h</td> <td>4-1/2</td> <td>1 5/8 or 3 5/8</td> </tr> <tr> <td>4 h</td> <td>4-5/8</td> <td>1 5/8 or 3 5/8</td> </tr> </tbody> </table>		#Layer & Size	Stud Depth		1 h	1-5/8	3 5/8 *	-	1 h	1-1/2	2 1/2 or 3 5/8 **	2 h	2-1/2	1 5/8 or 3 5/8	2 h	2-5/8	1 5/8 or 3 5/8	3 h	3-1/2	1 5/8 or 3 5/8	3 h	3-5/8	1 5/8 or 3 5/8	4 h	4-1/2	1 5/8 or 3 5/8	4 h	4-5/8	1 5/8 or 3 5/8	-
	#Layer & Size	Stud Depth																														
1 h	1-5/8	3 5/8 *	-																													
1 h	1-1/2	2 1/2 or 3 5/8 **																														
2 h	2-1/2	1 5/8 or 3 5/8																														
2 h	2-5/8	1 5/8 or 3 5/8																														
3 h	3-1/2	1 5/8 or 3 5/8																														
3 h	3-5/8	1 5/8 or 3 5/8																														
4 h	4-1/2	1 5/8 or 3 5/8																														
4 h	4-5/8	1 5/8 or 3 5/8																														

Non-Load Bearing Walls – Underwriters Laboratories Inc.

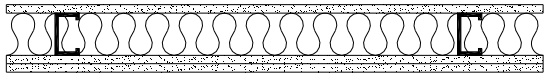
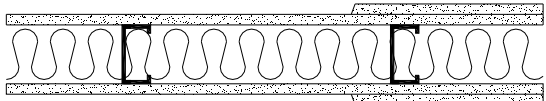
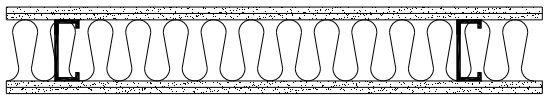
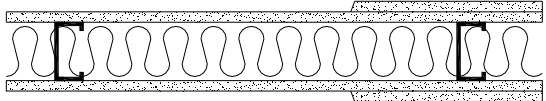
Source	Description	Fire Resistance Rating	Sound Transmission Class
UL W401	<ul style="list-style-type: none"> • 2½" x 25 MSG steel studs spaced at 24" o.c. • 2½" glass fibre insulation • 1 layer ½" gypsum board on one side • 2 layers ½" gypsum board on other side 		
		1 h	-
UL W403	<ul style="list-style-type: none"> • 3½" x 1½" x 20 MSG steel studs spaced at 16" o.c. • 1 hour - 1 layer of 5⁄8" gypsum board on each side • 2 hour – 2 layers of 5⁄8" gypsum board on each side • optional glass fiber or mineral wool insulation 		
		1 h 2 h	-
UL W405	<ul style="list-style-type: none"> • 3⁵⁄₈" x 25 MSG steel studs spaced at 24" o.c. • 2 layers of 3⁄₈" gypsum board on each side • optional glass fiber or mineral wool insulation 		
		1 h	-
UL W406	<ul style="list-style-type: none"> • 3 ½" (1 hour) and 2½" (2 hour) steel studs spaced at 24" o.c. • 1 hour - 1 layer of 5⁄₈" gypsum board on each side • 2 hour – 2 layers of 5⁄₈" gypsum board on each side • optional glass fiber insulation 		
		1 h 2 h	-

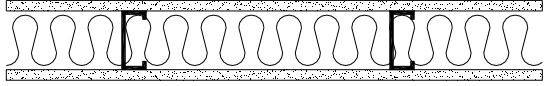
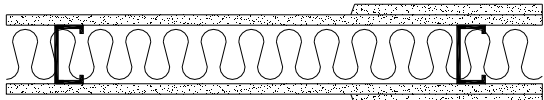
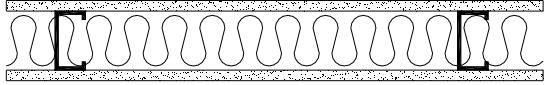

Non-Load Bearing Walls – Underwriters Laboratories Inc.

Source	Description	Fire Resistance Rating	Sound Transmission Class
UL W410	<ul style="list-style-type: none"> • 3⁵/₈" x 1¹/₄" x 20 MSG steel studs spaced at 16" o.c. • 1 layer of 5⁸/₈" gypsum board on each side • optional glass fiber or mineral wool insulation 	 <div style="display: flex; justify-content: space-around; width: 100%;"> 1 h - </div>	
UL W411 EQ	<ul style="list-style-type: none"> • 3 5⁸/₈" x 25 MSG steel studs spaced at 24" o.c. • 1/2 hour - 1 layer of 5⁸/₈" gypsum board on each side • 1 hour – 2 layers of 5⁸/₈" gypsum board on each side • optional glass fiber or mineral wool insulation • optional resilient furring channels, 25 MSG spaced at 24" o.c. 	 <div style="display: flex; justify-content: space-around; width: 100%;"> 1/2 h 1 h - </div>	
UL W412	<ul style="list-style-type: none"> • 2 1²/₈" x 25 MSG (3/4 hour) and 3⁵/₈" x 25 MSG (1 hour) steel studs spaced at 24" o.c. • 3/4 hour - 1 layer of 5⁸/₈" gypsum board on each side • 1 hour – 1 layer of 5⁸/₈" gypsum board on each side • 3¹/₂" glass fiber insulation for 1 hour and optional for 3/4 hour 	 <div style="display: flex; justify-content: space-around; width: 100%;"> 3/4 h 1 h - </div>	

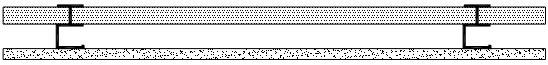
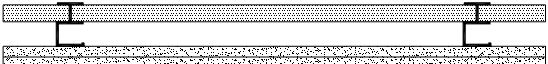
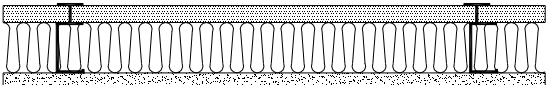
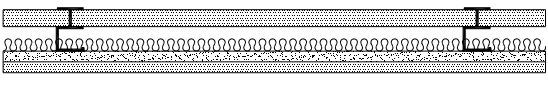

Non-Load Bearing Shaft Walls – Underwriters Laboratories Inc.

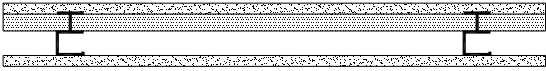
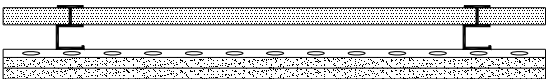
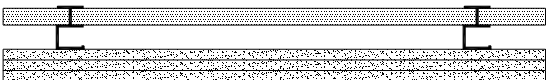
Source	Description	Fire Resistance Rating	Sound Transmission Class
UL U415	<p>System A</p> <ul style="list-style-type: none"> • 2 ½" x 25 MSG "C-H" shaped studs spaced at 24" o.c. • 1 layer 1" gypsum liner board panels on one side • 1 layer of 5/8" gypsum wallboard on other side 	 <p style="text-align: center;">1 h</p>	-
	<p>System B</p> <ul style="list-style-type: none"> • 2 ½" x 25 MSG "C-H" shaped studs spaced at 24" o.c. • 1 layer 1" gypsum liner board panels on one side • 2 layers of ½" or 5/8" gypsum wallboard on other side 	 <p style="text-align: center;">2 h</p>	-
	<p>System C</p> <ul style="list-style-type: none"> • 4" x 25 MSG "C-H" shaped studs spaced at 24" o.c. • 3" min. mineral wool batts • 1 layer 1" gypsum liner board panels on one side • 1 layer of 3/4" gypsum wallboard on other side 	 <p style="text-align: center;">2 h</p>	-
	<p>System D</p> <ul style="list-style-type: none"> • 2 ½" x 20 MSG "C-H" shaped studs spaced at 24" o.c. • 1 layer 1" gypsum liner board panels on one side • 1 ½" min. mineral wool batts • 1 layer of 5/8" gypsum wallboard and 1 layer of ½" or 5/8" cementitious board designated "Durock" on other side 	 <p style="text-align: center;">2 h</p>	-

Non-Load Bearing Shaft Walls – Underwriters Laboratories Inc.

Source	Description	Fire Resistance Rating	Sound Transmission Class
UL U415 (cont.)	<p>System E</p> <ul style="list-style-type: none"> • 2 ½" x 25 MSG "C-H" shaped studs spaced at 24" o.c. • 1 layer 1" gypsum liner board panels on one side • 1 layer of ½" or ⅝" gypsum wallboard on each side 		<p>2 h</p> <p>-</p>
	<p>System F</p> <ul style="list-style-type: none"> • 2 ½" x 25 MSG "C-H" shaped studs spaced at 24" o.c. • 1 layer 1" gypsum liner board panels on one side • furring channels spaced at 24" o.c. • 2 layers of ½" or ⅝" gypsum wallboard on other side 		<p>2 h</p> <p>-</p>
	<p>System G</p> <ul style="list-style-type: none"> • 2 ½" x 25 MSG "C-H" shaped studs spaced at 24" o.c. • 1 layer 1" gypsum liner board panels on one side • 3 layers of ⅝" gypsum wallboard on other side 		<p>3 h</p> <p>-</p>
	<p>System H</p> <ul style="list-style-type: none"> • 2 ½" x 25 MSG "C-H" shaped studs spaced at 24" o.c. • 1 layer 1" gypsum liner board panels on one side • 2 layers of ⅝" gypsum wallboard on other side 		<p>3 h</p> <p>-</p>

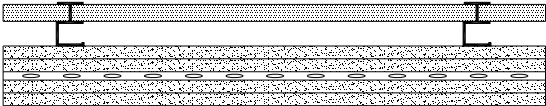
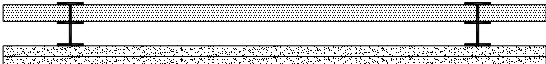
Non-Load Bearing Shaft Walls – Underwriters Laboratories Inc.

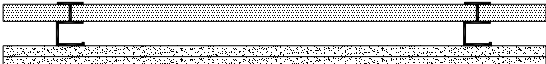
Source	Description	Fire Resistance Rating	Sound Transmission Class
UL U415 (cont.)	System I <ul style="list-style-type: none"> • 2 ½" x 25 MSG "C-H" shaped studs spaced at 24" o.c. • 1 layer 1" gypsum liner board panels on one side • 4 layers of ¾" gypsum wallboard on other side • furring channels spaced at 24" o.c. and applied over second layer 		
		4 h	-
UL U417 a) Intertek 3123470EEV b) RAL 437362 1976	System A <ul style="list-style-type: none"> • 2½" x 1½" x 25 MSG "I" shaped steel studs spaced at 24" o.c. • 1" gypsum board on one side • 2 layers of ½" or ⅝" gypsum board on other side 		
		2 h	39* (G ½") 41* (G ⅝") 50 ^a (GFB/RFB ¾" G ⅝" RC) 50 ^b (GFB/RFB ¼")
	System B <ul style="list-style-type: none"> • 2½" x 1½" x 25 MSG "I" shaped steel studs spaced at 24" o.c. • inner layer of 1" gypsum board on one side • 1 layer of ½" or ⅝" gypsum board on each side 		
		2 h	50 ^a (GFB/RFB ¾" RC)
	System C <ul style="list-style-type: none"> • 2½" x 1½" x 25 MSG "C-T" or "C-H" shaped steel studs spaced at 24" o.c. • 1 layer 1" gypsum board on one side • 2 layers of ½" or ⅝" gypsum board on other side 		
		2 h	50 ^a (GFB/RFB ¾" G ⅝" RC) 50 ^b (GFB/RFB ¼")

* Estimated value as per Warnock (2008)

Non-Load Bearing Shaft Walls – Underwriters Laboratories Inc.

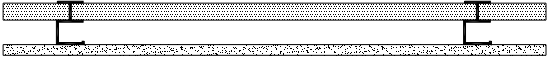
Source	Description	Fire Resistance Rating	Sound Transmission Class
UL U417 (cont.) a) Intertek 3123470EEV	System D <ul style="list-style-type: none"> • 2½" x 1½" x 25 MSG "C-T" or "C-H" shaped steel studs spaced at 24" o.c. • inner layer of 1" gypsum board on one side, with ½" or ⅝" gypsum board outer layer • 1 layer of ½" or ⅝" gypsum board on other side 		2 h 50 ^a (GFB/RFB 3¾" RC)
	System E <ul style="list-style-type: none"> • 2½" x 1½" x 25 MSG "I" shaped steel studs spaced at 24" o.c. • 1 layer 1" gypsum board on one side • 1 layer of ⅝" gypsum board on other side 		
	System F <ul style="list-style-type: none"> • 2½" x 1½" x 25 MSG "C-T" or "C-H" shaped steel studs spaced at 24" o.c. • 1 layer 1" gypsum board on one side • 1 layer of ⅝" gypsum board on other side 		1 h 42 ^a (GFB/RFB 3⅞")
	System G <ul style="list-style-type: none"> • 2½" x 1½" x 25 MSG "I" shaped steel studs spaced at 24" o.c. • 1 layer 1" gypsum board on one side • 3 layers of ⅝" gypsum board on other side 		

Non-Load Bearing Shaft Walls – Underwriters Laboratories Inc.

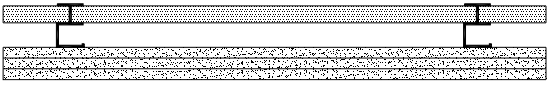
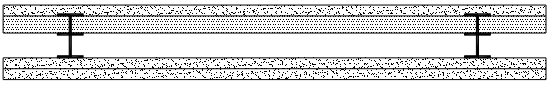
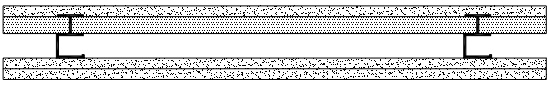
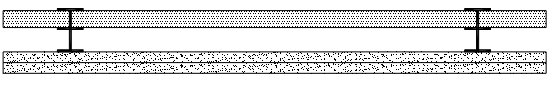
Source	Description	Fire Resistance Rating	Sound Transmission Class
UL U417 (cont.) a) Intertek 3123470EEV c) NGC Testing 2006038	System H <ul style="list-style-type: none"> • 2½" x 1½" x 25 MSG "C-T" or "C-H" shaped steel studs spaced at 24" o.c. • 1 layer 1" gypsum board on one side • 3 layers of 5⁄8" gypsum board on other side 		
	System I <ul style="list-style-type: none"> • 2½" x 1½" x 25 MSG "I" shaped steel studs spaced at 24" o.c. • inner layer of 1" gypsum board on one side, with 5⁄8" gypsum board outer layer • 2 layers of 5⁄8" gypsum board on other side 		3 h 50 ^a (GFB/RFB 4¾")
	System J <ul style="list-style-type: none"> • 2½" x 1½" x 25 MSG "C-T" or "C-H" shaped steel studs spaced at 24" o.c. • inner layer of 1" gypsum board on one side, with 5⁄8" gypsum board outer layer • 2 layers of 5⁄8" gypsum board on other side 		3 h 52 ^c (GFB/RFB 4¾")
UL V433	System A <ul style="list-style-type: none"> • 2 ½" x 1 ½" x 25 MSG "I"-shaped steel studs spaced 24" o.c. with ¾" wide by 2 ¼" high holding tabs • 1" gypsum board on one side • 2 layers of ½" or 5⁄8" gypsum board on other side 		2 h -

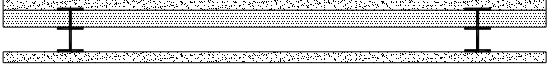
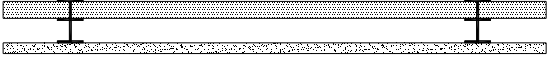
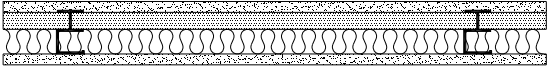
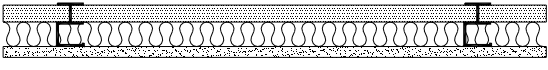

Non-Load Bearing Shaft Walls – Underwriters Laboratories Inc.

Source	Description	Fire Resistance Rating	Sound Transmission Class
UL V433 (cont.)	<p>System B</p> <ul style="list-style-type: none"> • 2 ½" x 1 ½" x 25 MSG "I"-shaped steel studs spaced 24" o.c. with ¾" wide by 2 ¼" high holding tabs • inner layer of 1" gypsum board on one side • 1 layer of ½" or ⅝" gypsum board on each side 	 <p style="text-align: center;">2 h</p>	-
	<p>System C</p> <ul style="list-style-type: none"> • 2 ½" x 1 ½" x 25 MSG "I"-shaped steel studs spaced 24" o.c. with ¾" wide by 2 ¼" high holding tabs • 1" gypsum board on one side • 1 layer of ⅝" gypsum board on other side 	 <p style="text-align: center;">1 h</p>	-
UL V472	<ul style="list-style-type: none"> • 2½" x 1⅝" x 25 MSG "C-T" or "C-H" shaped steel studs spaced at 24" o.c. • inner layer of 1" gypsum board on one side, with ½" or ⅝" gypsum board outer layer • 1 layer of ½" or ⅝" gypsum board on other side • optional glass fiber or mineral wool insulation 	 <p style="text-align: center;">2 h</p>	-
UL V473	<p>System A</p> <ul style="list-style-type: none"> • 2½" x 25 MSG "C-T" or "C-H" shaped steel studs spaced at 24" o.c. • 1" gypsum board on one side • 1 layer of ⅝" gypsum board on other side • optional glass fiber or mineral wool insulation 	 <p style="text-align: center;">1 h</p>	-

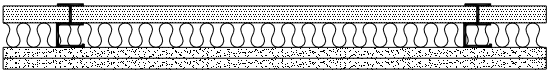
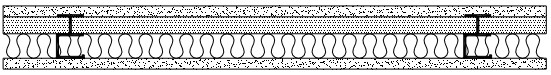
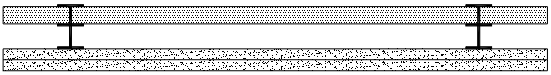
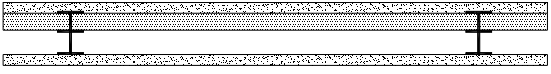
Non-Load Bearing Shaft Walls – Underwriters Laboratories Inc.

Source	Description	Fire Resistance Rating	Sound Transmission Class
UL V473 (cont.)	<p>System B</p> <ul style="list-style-type: none"> • 2½" x 25 MSG "C-T" or "C-H" shaped steel studs spaced at 24" o.c. • 1" gypsum board on one side • 2 layers of 5/8" gypsum board on other side • optional glass fiber or mineral wool insulation 		-
	2 h		
	<p>System C</p> <ul style="list-style-type: none"> • 2½" x 25 MSG "C-T" or "C-H" shaped steel studs spaced at 24" o.c. • inner layer of 1" gypsum board on one side, with 5/8" gypsum board outer layer • 1 layer of 5/8" gypsum board on other side • optional glass fiber or mineral wool insulation 		-
	2 h		
UL V481	<p>System A</p> <ul style="list-style-type: none"> • 2½" x 1½" x 25 MSG "I" shaped steel studs spaced at 24" o.c. • 1" gypsum board on one side • 2 layers of ½" or 5/8" gypsum board on other side • optional glass fiber or mineral wool insulation 		-
	2 h		
	<p>System B</p> <ul style="list-style-type: none"> • 2½" x 1½" x 25 MSG "I" shaped steel studs spaced at 24" o.c. • inner layer of 1" gypsum board on one side • 1 layer of ½" or 5/8" gypsum board on each side • optional glass fiber or mineral wool insulation 		-
	2 h		

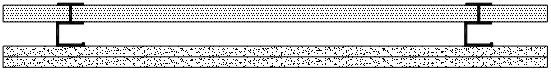

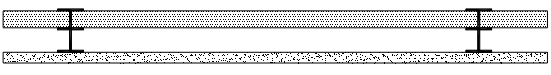
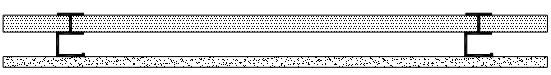
Non-Load Bearing Shaft Walls – Underwriters Laboratories Inc.

Source	Description	Fire Resistance Rating	Sound Transmission Class	
UL V481 (cont.)	<p>System C</p> <ul style="list-style-type: none"> • 2½" x 1½" x 25 MSG "C-T" or "C-H" shaped steel studs spaced at 24" o.c. • 1 layer 1" gypsum board on one side • 2 layers of ½" or ⅝" gypsum board on other side • optional glass fiber or mineral wool insulation 			
	<p>System D</p> <ul style="list-style-type: none"> • 2½" x 1½" x 25 MSG "C-T" or "C-H" shaped steel studs spaced at 24" o.c. • inner layer of 1" gypsum board on one side, with ½" or ⅝" gypsum board outer layer • 1 layer of ½" or ⅝" gypsum board on other side • optional glass fiber or mineral wool insulation 			
	<p>System E</p> <ul style="list-style-type: none"> • 2½" x 1½" x 25 MSG "I" shaped steel studs spaced at 24" o.c. • 1 layer 1" gypsum board on one side • 1 layer of ⅝" gypsum board on other side • optional glass fiber or mineral wool insulation 			
	<p>System F</p> <ul style="list-style-type: none"> • 2½" x 1½" x 25 MSG "C-T" or "C-H" shaped steel studs spaced at 24" o.c. • 1 layer 1" gypsum board on one side • 1 layer of ⅝" gypsum board on other side • optional glass fiber or mineral wool insulation 			
	2 h	-	2 h	-
	1 h	-	1 h	-

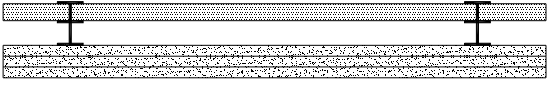
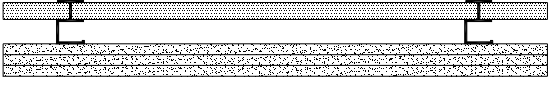
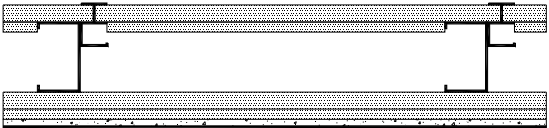
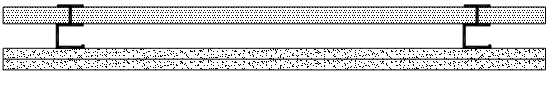
Non-Load Bearing Shaft Walls – Underwriters Laboratories Inc.

Source	Description	Fire Resistance Rating	Sound Transmission Class
UL V481 (cont.)	<p>System G</p> <ul style="list-style-type: none"> • 2½" x 1½" x 25 MSG "I" shaped steel studs spaced at 24" o.c. • 1 layer 1" gypsum board on one side • 3 layers of 5⁄8" gypsum board on other side • optional glass fiber or mineral wool insulation 	 <p style="text-align: center;">3 h</p>	-
	<p>System H</p> <ul style="list-style-type: none"> • 2½" x 1½" x 25 MSG "C-T" or "C-H" shaped steel studs spaced at 24" o.c. • 1 layer 1" gypsum board on one side • 3 layers of 5⁄8" gypsum board on other side • optional glass fiber or mineral wool insulation 	 <p style="text-align: center;">3 h</p>	-
UL W402	<ul style="list-style-type: none"> • 4" x 14 gauge channel shaped studs fastened to 2½" x 20 gauge "C-H" shaped channel spaced at 23⁵⁄₈" o.c. • 1 layer of 1" mineral and fibre board liner panels with 9⁄₁₆" cover strips on one side • 2 layers of mineral and fibre board liner panels, base layer 1" and 9⁄₁₆" secondary layer and 3⁄₈" steel skin cementitious panels on other side 	 <p style="text-align: center;">3 h</p>	-
UL W409	<p>System A</p> <ul style="list-style-type: none"> • 2½" x 1½" x 25 MSG "C-T" shaped steel studs spaced at 24" o.c. • 1 layer 1" gypsum liner board panels on one side • 2 layers of ½" or 5⁄8" gypsum board on other side 	 <p style="text-align: center;">2 h</p>	-

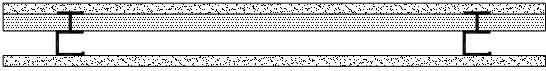
Non-Load Bearing Shaft Walls – Underwriters Laboratories Inc.

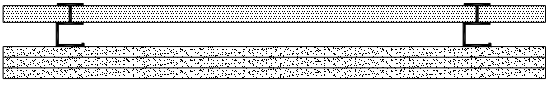
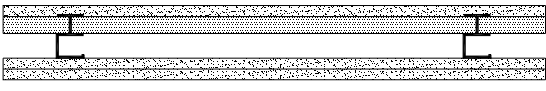
Source	Description	Fire Resistance Rating	Sound Transmission Class
UL W409 (cont.)	<p>System B</p> <ul style="list-style-type: none"> • 2½" x 1½" x 25 MSG "C-T" shaped steel studs spaced at 24" o.c. • 1 layer 1" gypsum liner board panels on one side • 1 layer of ½" or ⅝" gypsum wallboard on each side 	 <p style="text-align: center;">2 h</p>	-
	<p>System C</p> <ul style="list-style-type: none"> • 2½" x 1½" x 25 MSG "C-T" shaped steel studs spaced at 24" o.c. • 1 layer 1" gypsum liner board panels on one side • 1 layer of ⅝" gypsum wallboard on other side 	 <p style="text-align: center;">1 h</p>	-
	<p>System D</p> <ul style="list-style-type: none"> • 2½" x 1½" x 25 MSG "C-T" shaped steel studs spaced at 24" o.c. • 1 layer 1" gypsum liner board panels on one side • 3 layers of ⅝" gypsum wallboard on other side 	 <p style="text-align: center;">3 h</p>	-
	<p>System E</p> <ul style="list-style-type: none"> • 2½" x 1½" x 25 MSG "C-T" shaped steel studs spaced at 24" o.c. • 1 layer 1" gypsum liner board panels and 1 layer of ⅝" gypsum wallboard on one side • 2 layers of ⅝" gypsum wallboard on other side 	 <p style="text-align: center;">3 h</p>	-

Non-Load Bearing Shaft Walls – Underwriters Laboratories Inc.

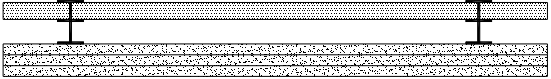
Source	Description	Fire Resistance Rating	Sound Transmission Class
UL W414	<ul style="list-style-type: none"> • 2½" x 1½" x 25 MSG "I" shaped steel studs spaced at 24" o.c. • 1 layer 1" gypsum board on one side • 3 layers of 5⁄8" gypsum board on other side 		
		3 h	-

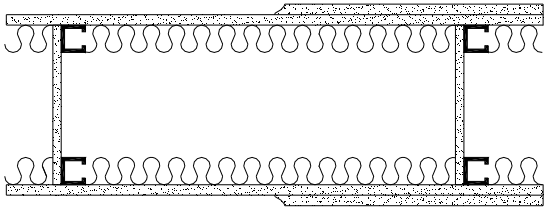
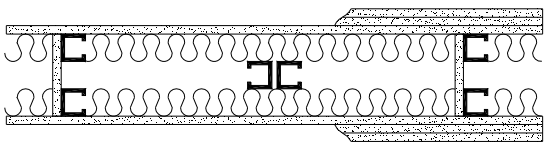
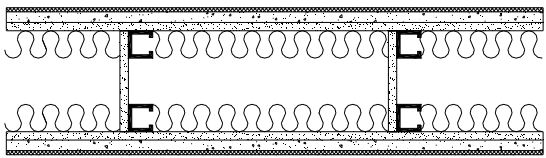

Non-Load Bearing Chase Walls – Underwriters Laboratories Inc.

Source	Description	Fire Resistance Rating	Sound Transmission Class																			
UL U420 EQ	<ul style="list-style-type: none"> 1 5/8" x 25 MSG steel studs spaced at 24" o.c. steel (4 1/4" long) or gypsum (9 1/2" long) bracing in stud cavity optional glass fiber insulation, 2 1/2" max. for 2 hour and 3 1/2" max. for 1 hour 1 hour - 1 layer of 5/8" gypsum board on each side 2 hour – 2 layers of 5/8" gypsum board on each side 																					
		1 h 2 h	-																			
UL U436 EQ	<ul style="list-style-type: none"> 1 5/8" x 1" x 25 MSG steel studs spaced at 24" o.c. steel truss members in cavity between steel studs optional glass fiber or mineral wool insulation gypsum wallboard layers, wallboard thickness and corresponding rating as shown 																					
		<table border="1"> <tr> <td></td> <td>#Layer & Size</td> <td></td> </tr> <tr> <td>1 h</td> <td>1-5/8"</td> <td>-</td> </tr> <tr> <td>2 h</td> <td>2-1/2"</td> <td>-</td> </tr> <tr> <td>2 h</td> <td>2-5/8"</td> <td>-</td> </tr> <tr> <td>3 h</td> <td>2-3/4"</td> <td>-</td> </tr> <tr> <td>3 h</td> <td>3-1/2"</td> <td>-</td> </tr> <tr> <td>3 h</td> <td>3-5/8"</td> <td>-</td> </tr> </table>		#Layer & Size		1 h	1-5/8"	-	2 h	2-1/2"	-	2 h	2-5/8"	-	3 h	2-3/4"	-	3 h	3-1/2"	-	3 h	3-5/8"
	#Layer & Size																					
1 h	1-5/8"	-																				
2 h	2-1/2"	-																				
2 h	2-5/8"	-																				
3 h	2-3/4"	-																				
3 h	3-1/2"	-																				
3 h	3-5/8"	-																				
UL U444 EQ	<ul style="list-style-type: none"> 1 5/8" x 1 1/4" x 20 MSG steel studs spaced at 16" o.c. steel or gypsum bracing in stud cavity min. 1 1/2" mineral wool insulation 1/2" gypsum board, 1/2" or 5/8" cementitious board and 1/4" ceramic tile on each side 																					
		2 h	-																			

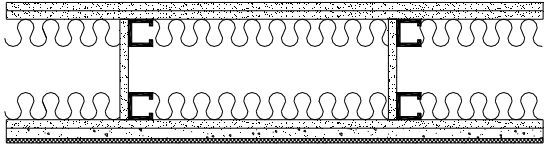
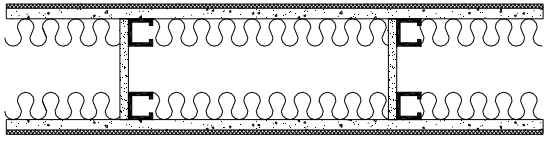
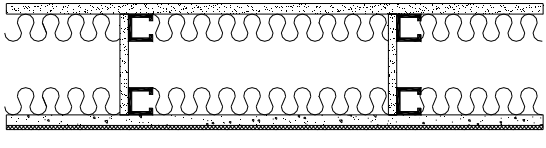
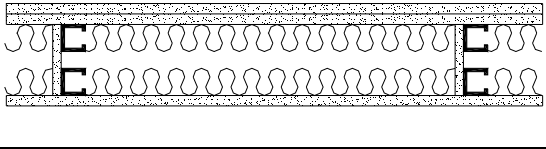
Non-Load Bearing Chase Walls – Underwriters Laboratories Inc.

Source	Description	Fire Resistance Rating	Sound Transmission Class
UL U444 (cont.) EQ	Alternate Construction <ul style="list-style-type: none"> • 1 5/8" x 1 1/4" x 20 MSG steel studs spaced at 16" o.c. • steel or gypsum bracing in stud cavity • min. 1 1/2" mineral wool insulation • 2 layers 1/2" gypsum board on one side • 1/2" gypsum board, 1/2" or 5/8" cementitious board and 1/4" ceramic tile on other side 	 2 h	-
UL U445	<ul style="list-style-type: none"> • 1 5/8" x 1 1/4" x 20 MSG steel studs spaced at 16" o.c. • steel or gypsum bracing in stud cavity • min. 1 1/2" mineral wool insulation • 1/2" or 5/8" cementitious board and 1/4" ceramic tile on each side 	 1 h	-
	Alternate Construction <ul style="list-style-type: none"> • 1 5/8" x 1 1/4" x 20 MSG steel studs spaced at 16" o.c. • steel or gypsum bracing in stud cavity • min. 1 1/2" mineral wool insulation • 1 layer 5/8" gypsum board on one side • 1/2" or 5/8" cementitious board and 1/4" ceramic tile on other side 	 1 h	-
UL U466 EQ	<ul style="list-style-type: none"> • 1 5/8" x 1 1/4" x 25 MSG steel studs spaced at 24" o.c. • optional glass fiber or mineral wool batts and blankets or spray applied cellulose insulation • 2 layers 5/8" gypsum board on one side • 1 layer 5/8" gypsum board on other side 	 1 h	-

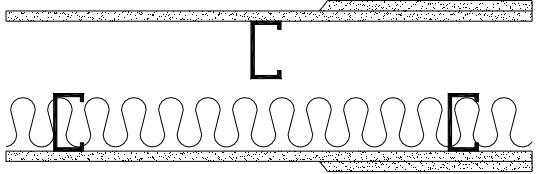
Non-Load Bearing Chase Walls – Underwriters Laboratories Inc.

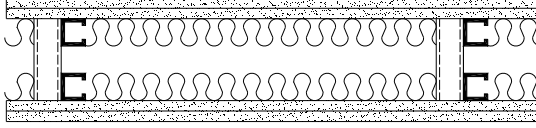
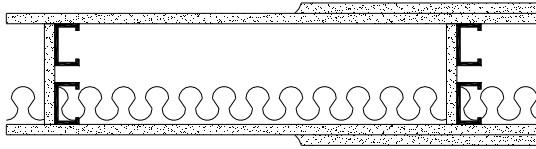
Source	Description	Fire Resistance Rating	Sound Transmission Class
UL U493 	<ul style="list-style-type: none"> • 2 1/2" x 1 5/8" x 25 MSG steel studs spaced at 24" o.c. • 3 1/2" glass fiber insulation on one side of wall assembly with nom. density of 0.5 pcf • 1 hour - 1 layer 5/8" or 3/4" gypsum board on each side • 2 hour – 2 layers 5/8" gypsum board on each side 	 1 h 2 h	-
UL V437 	<ul style="list-style-type: none"> • 1 5/8" x 1 1/4" x 25 MSG steel studs spaced at 24" o.c. • mineral wool or glass fiber batts • 2 layers 5/8" gypsum board on each side • steel runners or stud bracing, cavity width, spaced 48" o.c. 	 1 h	-
UL V442	<ul style="list-style-type: none"> • 2 1/2" x 1 3/8" x 22 MSG steel studs spaced at 24" o.c. • glass fiber insulation • steel or gypsum bracing in stud cavity • 1 hour - 1 layer 5/8" gypsum board on each side • 2 hour – 2 layers 5/8" gypsum board on each side 	 1 h 2 h	-

Non-Load Bearing Chase Walls – Underwriters Laboratories Inc.

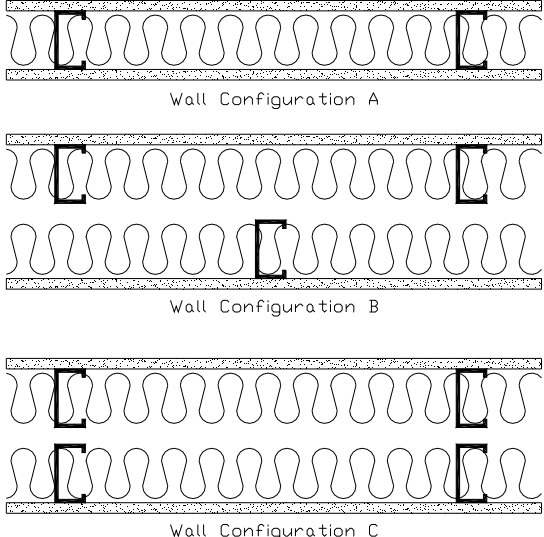
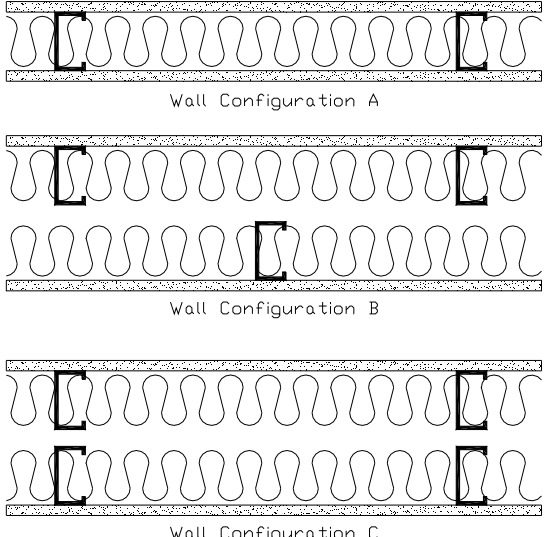
Source	Description	Fire Resistance Rating	Sound Transmission Class
UL V463	<ul style="list-style-type: none"> 3 1/2" x 1 1/2" x 25 MSG steel stud spaced as follows: Configuration B: 8" or 12" o.c. Configuration C: 16" or 24" o.c. 3 1/2" glass fiber insulation with nom. density of 0.95 pcf 1 layer of 5/8" "QuietRock" soundproof drywall on each side 	 <p style="text-align: center;">Wall Configuration A</p> <p style="text-align: center;">Wall Configuration B</p> <p style="text-align: center;">Wall Configuration C</p>	<p style="text-align: center;">1 h</p> <p style="text-align: center;">-</p>
UL V464 EQ	<ul style="list-style-type: none"> 3 5/8" proprietary steel stud (ClarkDietrich) with 0.0150" thickness and spaced as follows: Configuration B: 8" or 12" o.c. Configuration C: 16" or 24" o.c. 3 1/2" glass fiber insulation with nom. density of 0.95 pcf 1 layer of 5/8" "QuietRock" soundproof drywall on one side and 1 layer of 5/8" Type X gypsum board on other side 	 <p style="text-align: center;">Wall Configuration A</p> <p style="text-align: center;">Wall Configuration B</p> <p style="text-align: center;">Wall Configuration C</p>	<p style="text-align: center;">1 h</p> <p style="text-align: center;">56* (Configuration B) 61* (Configuration C)</p>

* Estimated value (see www.quietsolution.com/acousticfireassemblies.pdf)

Non-Load Bearing Chase Walls – Underwriters Laboratories Inc.

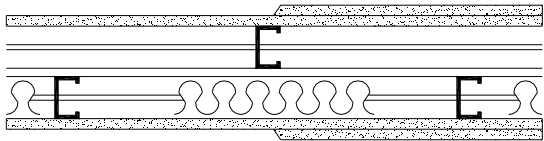
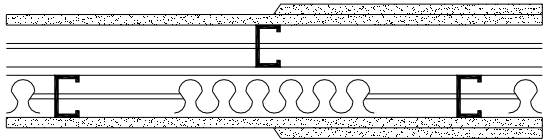
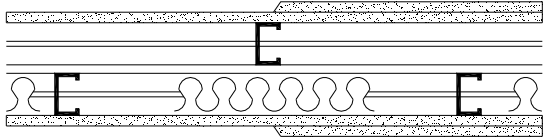
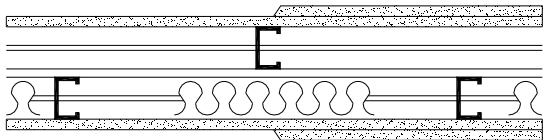
Source	Description	Fire Resistance Rating	Sound Transmission Class
UL V469	<ul style="list-style-type: none"> • 2 1/2" x 1 5/8" x 25 MSG steel studs spaced at 24" o.c. • optional glass fiber insulation on one or both rows of studs • 1 hour - 1 layer 5/8" gypsum board on each side • 2 hour – 2 layers 5/8" gypsum board on each side 		-
UL V488 EQ	<ul style="list-style-type: none"> • 2 1/2" x 1 5/8" x 25 MSG steel studs spaced at 24" o.c. • optional glass fiber insulation on one or both rows of studs • 1 hour - 1 layer 5/8" gypsum board on each side • 2 hour – 2 layers 5/8" gypsum board on each side 		-
UL V490	<ul style="list-style-type: none"> • 2 1/2" x 1 5/8" x 25 MSG steel studs spaced at 24" o.c. • optional glass fiber insulation on one or both rows of studs • 1 hour - 1 layer 5/8" gypsum board on each side • 2 hour – 2 layers 5/8" gypsum board on each side 		-
UL W407	<ul style="list-style-type: none"> • 2 1/2" x 1 5/8" x 25 MSG steel studs spaced at 24" o.c. • optional glass fiber insulation on one or both rows of studs • 1 hour - 1 layer 5/8" gypsum board on each side • 2 hour – 2 layers 5/8" gypsum board on each side 		-

Non-Load Bearing Area Separation Walls – Underwriters Laboratories Inc.

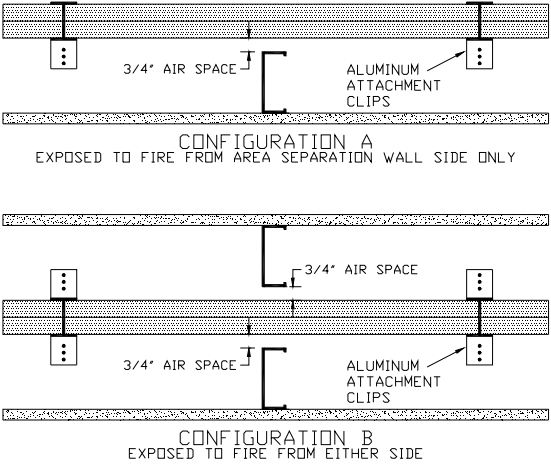
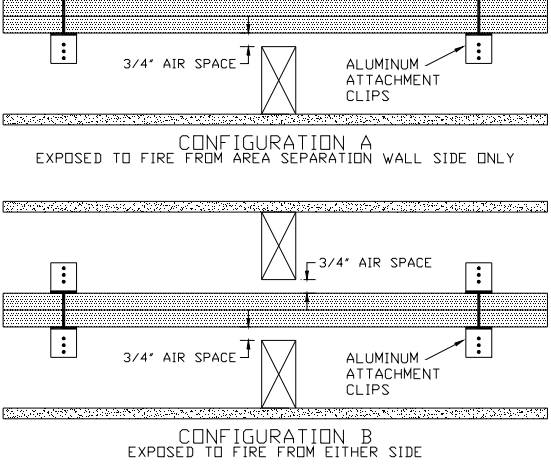
Source	Description	Fire Resistance Rating	Sound Transmission Class
UL U336	<p>Separation Wall (max. height – 66 ft)</p> <ul style="list-style-type: none"> • 2" x 1 3/8" x 25 MSG "H" shaped metal studs spaced at 24" o.c. • 2 layers of 1" thick gypsum board liner panels <p>Protected Wall (Bearing or Nonbearing Wall)</p> <ul style="list-style-type: none"> • 3 1/2" x 20 MSG steel studs spaced at 24" o.c. for Bearing Wall Rating • 3 1/2" x 1 1/4" x 25 MSG steel studs spaced at 24" o.c. for Nonbearing Wall Rating (Configuration B only) • 1 layer 1/2" gypsum board • aluminum attachment clips 	 <p style="text-align: center;">CONFIGURATION A EXPOSED TO FIRE FROM AREA SEPARATION WALL SIDE ONLY</p> <p style="text-align: center;">CONFIGURATION B EXPOSED TO FIRE FROM EITHER SIDE</p>	
		2 h	-
UL U366	<p>Separation Wall (max. height – 44 ft)</p> <ul style="list-style-type: none"> • 2" x 1 3/8" x 25 MSG "H" shaped metal studs spaced at 24" o.c. • 2 layers of 1" thick gypsum board liner panels <p>Protected Wall (Bearing or Nonbearing Wall)</p> <ul style="list-style-type: none"> • 4" x 2" wood studs spaced at 24" • 1 layer 1/2" gypsum board • aluminum attachment clips 	 <p style="text-align: center;">CONFIGURATION A EXPOSED TO FIRE FROM AREA SEPARATION WALL SIDE ONLY</p> <p style="text-align: center;">CONFIGURATION B EXPOSED TO FIRE FROM EITHER SIDE</p>	
		2 h	-

Non-Load Bearing Area Separation Walls – Underwriters Laboratories Inc.

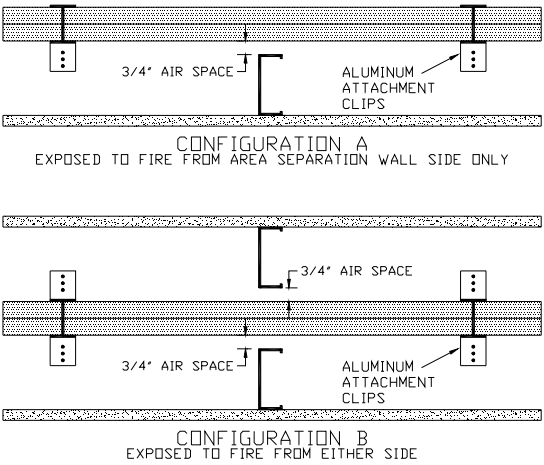
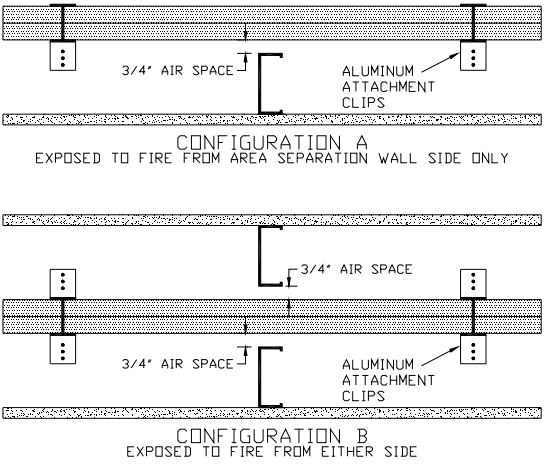
Source	Description	Fire Resistance Rating	Sound Transmission Class
UL U373	<p>Separation Wall (max. height – 44 ft)</p> <ul style="list-style-type: none"> • 2 1/8" x 1 1/2" x 25 MSG "H" shaped metal studs spaced at 24" o.c. • 2 layers of 1" thick gypsum board liner panels <p>Protected Wall (Bearing or Nonbearing Wall)</p> <ul style="list-style-type: none"> • 3 1/2" x 20 MSG steel studs spaced at 24" o.c. for Bearing Wall Rating • 3 1/2" x 1 1/4" x 25 MSG steel studs spaced at 24" o.c. for Nonbearing Wall Rating (Configuration B only) • 1 layer 1/2" gypsum board • optional glass fiber or mineral wool insulation • aluminum attachment clips 	 <p style="text-align: center;">CONFIGURATION A EXPOSED TO FIRE FROM AREA SEPARATION WALL SIDE ONLY</p> <p style="text-align: center;">CONFIGURATION B EXPOSED TO FIRE FROM EITHER SIDE</p>	
		2 h	-
UL U375	<p>Separation Wall (max. height – 66 ft)</p> <ul style="list-style-type: none"> • 2" x 1 3/8" x 25 MSG "H" shaped metal studs spaced at 24" o.c. • 2 layers of 1" thick gypsum board liner panels <p>Protected Wall (Bearing or Nonbearing Wall)</p> <ul style="list-style-type: none"> • 3 1/2" x 20 MSG steel studs spaced at 24" o.c. for Bearing Wall Rating • 3 1/2" x 1 1/4" x 25 MSG steel studs spaced at 24" o.c. for Nonbearing Wall Rating • 1 layer 1/2" gypsum board • aluminum attachment clips 	 <p style="text-align: center;">CONFIGURATION A EXPOSED TO FIRE FROM AREA SEPARATION WALL SIDE ONLY</p> <p style="text-align: center;">CONFIGURATION B EXPOSED TO FIRE FROM EITHER SIDE</p>	
		2 h	-

Non-Load Bearing Area Separation Walls – Underwriters Laboratories Inc.

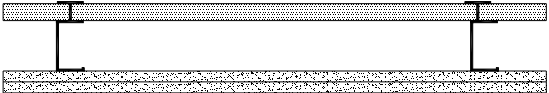
Source	Description	Fire Resistance Rating	Sound Transmission Class
UL U437	<ul style="list-style-type: none"> • 4" x 1½" x 20 MSG "C-H" shaped steel studs spaced at 24" o.c. • 1 layer of 1" thick gypsum board liner panels on one side • 1 hour - 1 layer 5/8" gypsum board on other side • 2 hour – 2 layers 5/8" gypsum board on other side • optional glass fiber or mineral wool insulation 		

Non-Load Bearing Walls – Gypsum Association

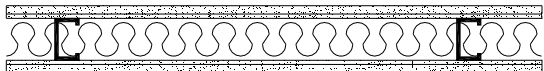
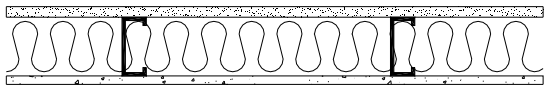
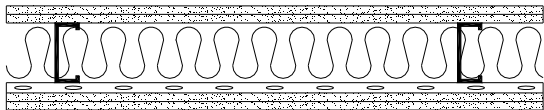
Source	Description	Fire Resistance Rating	Sound Transmission Class
GA WP1041 ASL AS-TL1510	<ul style="list-style-type: none"> • 3 5/8" x 20 gage steel studs spaced at 24" o.c. • inner layer 1/2" Type X gypsum board and outer layer 1/4" fiber-cement board on each side 		
		1 h	50 to 54
GA WP1051 NGC 2318	<ul style="list-style-type: none"> • 2 1/2" steel studs spaced at 24" o.c. • 2" glass fiber insulation • inner layer 1/4" gypsum board and outer layer 1/2" Type X gypsum board on each side 		
		1 h	50 to 54
GA WP1082 NGC 2099015	<ul style="list-style-type: none"> • 3 5/8" x 25 gage steel studs spaced at 16" o.c. • 3" mineral fiber insulation • 1 layer 5/8" Type X gypsum board on one side • 1 layer 1/2" cementitious board on other side 		
		1 h	45 to 49
GA WP1470 RAL TL83-214	<ul style="list-style-type: none"> • 3 1/2" x 20 gage steel studs spaced at 24" o.c. • 3" mineral fiber insulation • 2 layers 1/2" Type X gypsum board on one side • resilient channels spaced 24" o.c. and 2 layers 1/2" Type X gypsum board on other side 		
		2 h	55 to 59

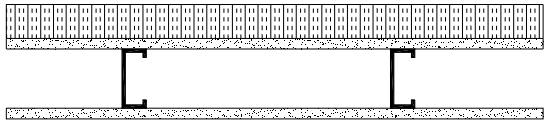
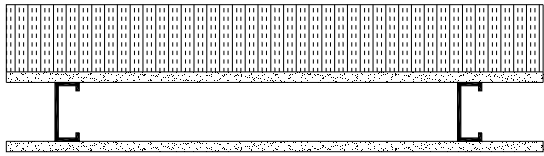
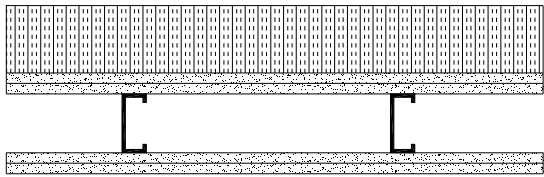
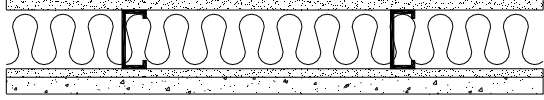

Non-Load Bearing Walls – Gypsum Association

Source	Description	Fire Resistance Rating	Sound Transmission Class
GA WP8122	<ul style="list-style-type: none"> • 3 $\frac{5}{8}$" x 18 gage steel studs spaced at 16" o.c. • 1 layer $\frac{5}{8}$" Type X gypsum board on one side • inner layer of $\frac{5}{8}$" Type X gypsum board and outer layer of 2" expanded polystyrene on other side 		
		1 h	-
GA WP8123	<ul style="list-style-type: none"> • 3 $\frac{5}{8}$" x 18 gage steel studs spaced at 24" o.c. • 1 layer $\frac{5}{8}$" Type X gypsum board on one side • inner layer of $\frac{5}{8}$" Type X gypsum board and outer layer of 4" expanded polystyrene on other side 		
		2 h	-
GA WP8202	<ul style="list-style-type: none"> • 3 $\frac{5}{8}$" x 18 gage steel studs spaced at 16" o.c. • 2 layers $\frac{5}{8}$" Type X gypsum board on one side • 2 layers of $\frac{5}{8}$" Type X gypsum board and 4" expanded polystyrene on other side 		
		2 h	-
GA WP8250	<ul style="list-style-type: none"> • 3 $\frac{5}{8}$" x 20 gage steel studs spaced at 16" o.c. • 3" mineral fiber insulation • 1 layer $\frac{5}{8}$" foil backed Type X gypsum board on one side • $\frac{1}{2}$" gypsum board with stucco finish on other side 		
		2 h	-

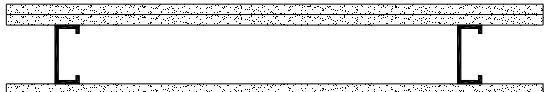
Non-Load Bearing Walls – Factory Mutual Research

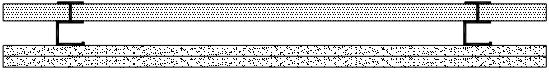

Source	Description	Fire Resistance Rating	Sound Transmission Class
FM Wall 1 USG810519	<ul style="list-style-type: none"> • 3 5/8" x 22 ga steel studs spaced at 24" o.c. • 1 layer 5/8" gypsum board on each side 		1 h 40
FM Wall 7 BBN760808	<ul style="list-style-type: none"> • 3 5/8" x 22 ga steel studs spaced at 24" o.c. • 2 layers 5/8" gypsum board on each side 		2 h 48

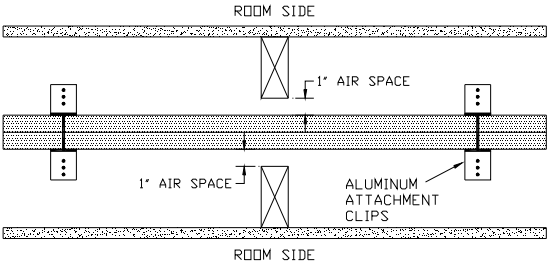
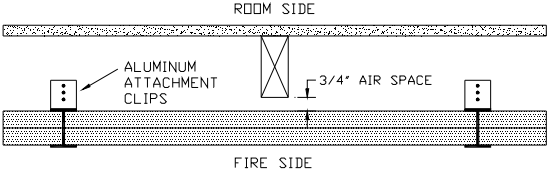
Non-Load Bearing Walls – Intertek Testing Services NA Inc.

Source	Description	Fire Resistance Rating	Sound Transmission Class
ITS DI/WA 120-01	<ul style="list-style-type: none"> 1½" wide by 2½" deep "C-T" shaped proprietary steel stud (ClarkDietrich) with 0.019" thickness* spaced at 24" o.c. 1 layer 1" Type X gypsum shaft liner on one side 2 layers ½" gypsum board on other side 		
		2 h	38 (as shown) 44 (RFB 1½") 53 (RFB ½" RC)
ITS DI/WA 120-02	<ul style="list-style-type: none"> 1½" wide by 2½" deep "C-T" shaped proprietary steel stud (ClarkDietrich) with 0.019" thickness* spaced at 24" o.c. 1 layer 1" Type X gypsum shaft liner and 1 layer ½" gypsum board on one side 1 layer ½" gypsum board on other side 		
		2 h	39 (as shown) 43 (RFB 1½") 51 (RFB ½" RC)
ITS DI/WA 120-03	<ul style="list-style-type: none"> 1½" wide by 2" deep "H" shaped proprietary steel stud (ClarkDietrich) with 0.018" thickness* spaced at 24" o.c. 2 layers 1" gypsum shaft liner aluminum attachment clips 1 layer ½" gypsum board on either side 2" x 4" wood studs spaced at 16" o.c. 		
		2 h	-
ITS DI/WA 120-04	<ul style="list-style-type: none"> 1½" wide by 2" deep "H" shaped proprietary steel stud (ClarkDietrich) with 0.018" thickness* spaced at 24" o.c. 2 layers 1" gypsum shaft liner on one side aluminum attachment clips 1 layer ½" gypsum board on other side 2" x 4" wood studs spaced at 24" o.c. 		
		2 h	-

* Larger thickness is also acceptable.

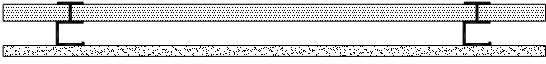
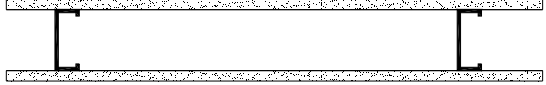
Non-Load Bearing Walls – Intertek Testing Services NA Inc.

Source	Description	Fire Resistance Rating	Sound Transmission Class
ITS MW/WA 60-01	<ul style="list-style-type: none"> 1½" wide by 2½" deep "C-T" shaped proprietary steel stud (Marino\WARE) with 25 gauge thickness* spaced at 24" o.c. 1 layer 1" Type X gypsum shaft liner on one side 1 layer 5⁄8" Type X or ½" Type C gypsum board on other side 		
		1 h	-
ITS MW/WA 60-02 60-04 EQ TL08-119 Western Electro – Acoustic Laboratory	<ul style="list-style-type: none"> 3 5⁄8", 4" or 6" depth proprietary steel stud (Marino\WARE) designated as VIPERSTUD25™ with 0.0155" thickness* spaced at 24" o.c. 1 layer 5⁄8" Type X gypsum board on each side 		
		1 h	41
ITS MW/WA 60-03 60-05 EQ	<ul style="list-style-type: none"> two rows of 3 5⁄8", 4" or 6" depth proprietary steel stud (Marino\WARE) designated as VIPERSTUD25™ with 0.0155" thickness* spaced at 24" o.c. min 1" spacing between studs from each row 1 layer 5⁄8" Type X gypsum board on each side 		
		1 h	-

* Larger thickness is also acceptable.

Non-Load Bearing Walls – Intertek Testing Services NA Inc.

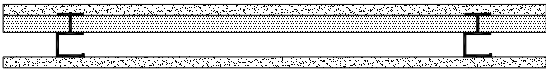
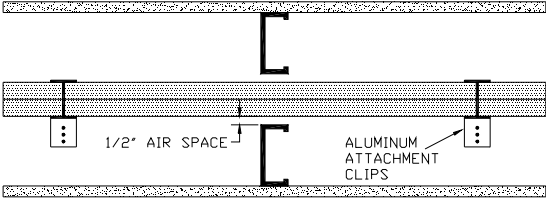
Source	Description	Fire Resistance Rating	Sound Transmission Class
ITS MW/WA 120-01	<ul style="list-style-type: none"> 1½" wide by 2½" deep "C-T" shaped proprietary steel stud (Marino\WARE) with 25 gauge thickness* spaced at 24" o.c. 1 layer 1" Type X gypsum shaft liner on one side 2 layers ⅝" Type X or ½" Type C gypsum board on other side 	 2 h	-
ITS MW/WA 120-02	<ul style="list-style-type: none"> 1½" wide by 2½" deep "C-T" shaped proprietary steel stud (Marino\WARE) with 25 gauge spaced at 24" o.c. 1 layer 1" Type X gypsum shaft liner and 1 layer ⅝" Type X or ½" Type C gypsum board on one side 1 layer ⅝" Type X or ½" Type C gypsum board on other side 	 2 h	-
ITS MW/WA 120-03	<p>Firewall (max. height – 50 feet)</p> <ul style="list-style-type: none"> 2" deep "H" shaped proprietary steel stud (Marino\WARE) with 25 gauge thickness* spaced at 24" o.c. 2 layers of 1" thick Type X gypsum wallboard liner panels <p>Protected Wall (Bearing or Nonbearing Wall)</p> <ul style="list-style-type: none"> min. 3½" depth steel stud spaced at 24" o.c. 1 layer ½" Type C gypsum board aluminum attachment clips 	 2 h	-

* Larger thickness is also acceptable.

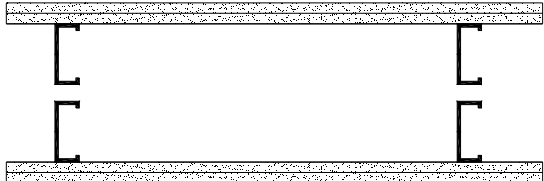

Non-Load Bearing Walls – Intertek Testing Services NA Inc.

Source	Description	Fire Resistance Rating	Sound Transmission Class
ITS MW/WA 120-04 120-05 EQ TL08-124 Western Electro – Acoustic Laboratory	<ul style="list-style-type: none"> 1 5/8", 2 1/2", 3 5/8", 4" or 6" depth proprietary steel stud (Marino\WARE) designated as VIPERSTUD25™ with 0.0155" thickness* spaced at 24" o.c. 2 layers 5/8" Type X gypsum board on each side <p>NOTE: Optional 3 1/2" fibreglass insulation required with resilient channel for STC=61 and using 3 5/8" steel stud.</p>		
		2 h	61
ITS MW/WA 120-06 120-07 EQ	<ul style="list-style-type: none"> 1 5/8", 2 1/2", 3 5/8", 4" or 6" depth proprietary steel stud (Marino\WARE) designated as VIPERSTUD25™ with 0.0155" thickness* spaced at 24" o.c. min 1" spacing between studs from each row 2 layers 5/8" Type X gypsum board on each side 		
		2 h	-

* Larger thickness is also acceptable.

LOAD BEARING WALL ASSEMBLIES

Load Bearing Walls – Underwriters Laboratories of Canada

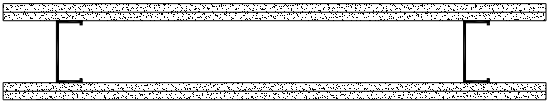
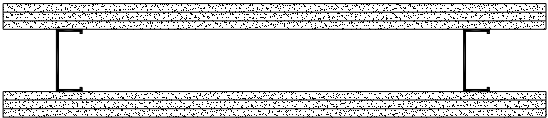
Source	Description	Fire Resistance Rating	Sound Transmission Class
<p>ULC W424</p> <p>a) USG810519 b) BBN760808</p>	<ul style="list-style-type: none"> 92 mm x 35 mm proprietary steel stud (Bailey Metal Products Ltd.), 0.9 mm thick spaced at 600 mm o.c. 1 layer of 15.9 mm Type X gypsum board (Canadian Gypsum Company, Sheetrock Firecode C) on each side 	 <p>1 h</p>	<p>40^a</p>
	<ul style="list-style-type: none"> 92 mm x 35 mm proprietary steel stud (Bailey Metal Products Ltd.), 0.9 mm thick spaced at 600 mm o.c. 2 layers of 15.9 mm Type X gypsum board (Canadian Gypsum Company, Sheetrock Firecode C) on each side <p>** 60% of Design Load</p>	 <p>** 2 h</p>	<p>48^b</p>
	<ul style="list-style-type: none"> 92 mm x 35 mm proprietary steel stud (Bailey Metal Products Ltd.), 0.9 mm thick spaced at 600 mm o.c. 2 layers of 12.7 mm Type X gypsum board (Canadian Gypsum Company, Sheetrock Firecode C) on each side <p>** 85% of Design Load</p>	 <p>** 1-1/2 h</p>	<p><50*</p>
	<ul style="list-style-type: none"> 92 mm x 35 mm proprietary steel stud (Bailey Metal Products Ltd.), 0.9 mm thick spaced at 600 mm o.c. 3 layers of 12.7 mm Type X gypsum board (Canadian Gypsum Company, Sheetrock Firecode C) on each side <p>** 60% of Design Load</p>	 <p>** 2 h</p>	<p>50*</p>

* Estimated value as per Warnock (2008)

Load Bearing Walls – Underwriters Laboratories of Canada

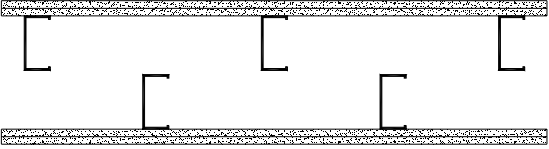
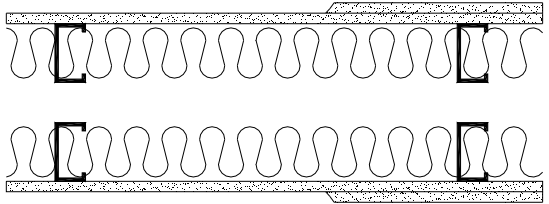
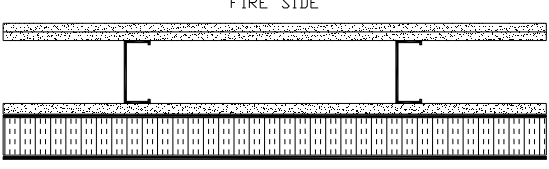
Source	Description	Fire Resistance Rating	Sound Transmission Class
ULC W445	<ul style="list-style-type: none"> double wall system with min 7 mm space between each 92 mm x 41 mm x 0.80 mm thick steel stud spaced at 400 mm o.c. 2 layers of 12.7 mm gypsum board on each side 		
		1-½ h	54*
ULC W449	<ul style="list-style-type: none"> double wall system with 89 mm x 41 mm x 0.86 mm thick steel stud spaced at 610 mm o.c. any glass fibre insulation with ULC Listing Mark with min. density of 8.0 kg/m³ 1 or 2 layers of 15.9 mm gypsum board on each side <p>** 80% of Design Load</p>		
		**1 h for 1–15.9mm 2 h for 2-15.9mm	58* (AIR 25mm) 59* (AIR 50mm) 68* (AIR 25mm) 69* (AIR 50mm)
ULC W485	<ul style="list-style-type: none"> 92 mm x 41 mm x 0.836 mm thick steel studs spaced at 406 mm o.c. inner 2 layers of 12.7 mm gypsum board 1 layer of 15.9 mm Type X gypsum board on other side 150 mm max. thick polystyrene insulation boards components in exterior wall insulation and finish system by Durabond Products Ltd. 		
		2 h	-

* Estimated value as per Warnock (2008)

Load Bearing Walls – Underwriters Laboratories of Canada

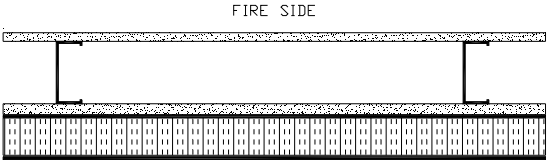
Source	Description	Fire Resistance Rating	Sound Transmission Class
ULC W489	<ul style="list-style-type: none"> • 92 mm x 41 mm x 0.836 mm thick steel studs spaced at 610 mm o.c. • inner 1 layer of 12.7 mm gypsum board • 1 layer of 15.9 mm Type X gypsum board on other side • 150 mm max. thick polystyrene insulation boards • components in exterior wall insulation and finish system by Durabond Products Ltd. 	<div style="text-align: center;">  </div>	-

Load Bearing Walls – Underwriters Laboratories Inc. for Canadian Application

As per Technical Note no. 8, UL Floor/Ceiling and Load Bearing Wall assemblies using cold-formed steel joists and studs can be used for Canadian application. Details regarding this condition are given in “*BXUV7.GuideInfo, Fire Resistance Ratings - CAN/ULC-S101 Certified for Canada*”. UL Load Bearing Wall assemblies that can be used for Canadian application as per BXUV7 are listed below and the relevant assemblies are noted with a BXUV7 symbol in the 1st column of the section showing UL Load Bearing Wall assemblies (see pages 137 to 145).

U404	U434	U490
U407	U440	V420
U418	U460	V432
U423	U462	V434
U424	U473	V446
U425	U477	V478
U426	U485	V479
U432	U487	V480

Load Bearing Walls – National Research Council of Canada

The following pages present load bearing wall assemblies fire tested at NRCC during a multi industry (steel, wood, gypsum and insulation) fire testing program that is reported on in a fire test report, namely A-4222.2 (February 2002). The fire test report no. appears in the source column and is followed by a “F” fire test no. used in the report. A relevant NRCC acoustic report is also listed below and this reference document deals with acoustic data, i.e., values of Sound Transmission Class that have been established as an estimated value or from an acoustic test where the acoustic test no. appears in the source column.

NRCC A-4222.2 data for F26 to F39 (see pages 134 to 136)



Reference (fire data):

Kodur, V.K.R., Sultan, M.A., Latour, J.C., Leroux, P. and Monette, R.C., *Fire Resistance Tests on Gypsum Board-Protected Loadbearing Steel Stud Walls, IRC Client Report No. A-4222.2*, National Research Council of Canada, Ottawa, Ontario, Canada, February 2002.

Reference (acoustic data):

* Warnock, A.C.C., *Estimation of Sound Transmission Class and Impact Insulation Class Rating for Steel Framed Assemblies*, Report No. B3436.1 Revised, Institute for Research in Construction, National Research Council of Canada, Ottawa, Ontario, Canada, November 2008.

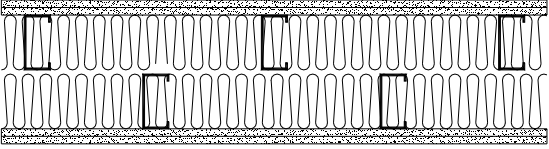
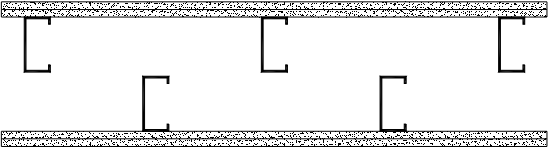
Load Bearing Walls – National Research Council of Canada

Source	Description	Fire Endurance	Sound Transmission Class
NRCC A4222.2 F26	<ul style="list-style-type: none"> double wall system with 92 mm deep x 0.91 mm thick steel stud spaced at 406 mm o.c. 39 mm wide diagonal strap bracing with 101 x 101 x 0.912 mm gusset plates 90 mm mineral fibre insulation 2 layers of 12.7 mm Type X gypsum board on each side 		
		84 min	64*
NRCC A4222.2 F30 F30R TLA-01-019a	<ul style="list-style-type: none"> double wall system with 92 mm deep x 0.91 mm thick steel stud spaced at 406 mm o.c. 39 mm wide diagonal strap bracing with 101 x 101 x 0.912 mm gusset plates 2 layers of 12.7 mm Type X gypsum board on each side <p>NOTE: F30R used to measure the repeatability of the results.</p>		
		F30 -100 min F30R -102 min	55
NRCC A4222.2 F37	<ul style="list-style-type: none"> 92 mm deep steel stud with 0.91 mm thickness spaced at 406 mm o.c. 39 mm wide diagonal strap bracing with 101 x 101 x 0.912 mm gusset plates steel resilient channels spaced 406 mm o.c. 2 layers of 12.7 mm Type X gypsum board on each side 		
		77 min	46*
NRCC A4222.2 F39	<ul style="list-style-type: none"> 92 mm deep steel stud with 0.91 mm thickness spaced at 406 mm o.c. 39 mm wide diagonal strap bracing with 101 x 101 x 0.912 mm gusset plates 2 layers of 12.7 mm Type X gypsum board on each side 		
		83 min	<50*

* Estimated value as per Warnock (2008)

Load Bearing Walls – National Research Council of Canada

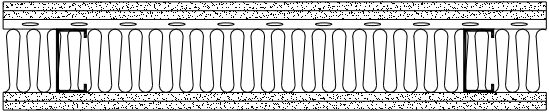
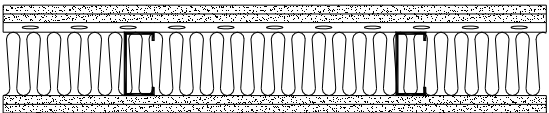
Source	Description	Fire Endurance	Sound Transmission Class
NRCC A4222.2 F28	<ul style="list-style-type: none"> 92 mm deep steel stud with 0.91 mm thickness spaced at 610 mm o.c. 39 mm wide diagonal strap bracing with 101 x 101 x 0.912 mm gusset plates steel resilient channels spaced 406 mm o.c. 90 mm mineral fibre insulation 2 layers of 12.7 mm Type X gypsum board on each side 		
		74 min	56*
NRCC A4222.2 F35 F36	<ul style="list-style-type: none"> 92 mm deep steel stud with 0.84 mm thickness spaced at 406 mm o.c. 39 mm wide diagonal strap bracing with 101 x 101 x 0.912 mm gusset plates steel resilient channels spaced 406 mm o.c. 90 mm glass fibre insulation 2 layers of 12.7 mm Type X gypsum board on each side <p>NOTE: Applied load varies between two tests; F35=78.4kN, F36=70.9kN</p>		
		F35 = 68 min F36 = 63 min	55*

* Estimated value as per Warnock (2008)

Load Bearing Walls – National Research Council of Canada

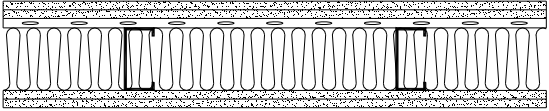
Source	Description	Fire Endurance	Sound Transmission Class
NRCC A4222.2 F27 F31 F38	<ul style="list-style-type: none"> • 92 mm deep steel stud with 0.91 mm thickness spaced at 406 mm o.c. • 39 mm wide diagonal strap bracing with 101 x 101 x 0.912 mm gusset plates • steel resilient channels spaced 406 mm o.c. • insulation (see below) • 2 layers of 12.7 mm Type X gypsum board on each side <p>F27 - 90 mm glass fibre insulation F31 - 90 mm cellulose insulation F38 - 90 mm mineral fibre insulation</p>		
		<p>F27 = 56 min F31 = 71 min F38 = 59 min</p>	<p>55* 54* 54*</p>

* Estimated value as per Warnock (2008)

Load Bearing Walls – Underwriters Laboratories Inc.

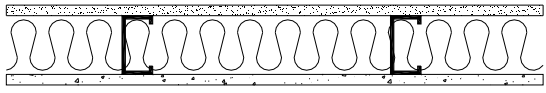
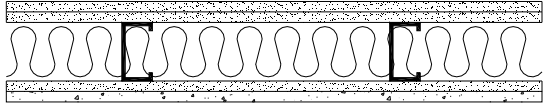
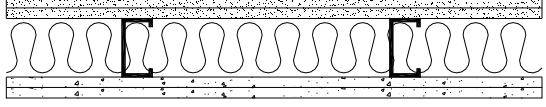
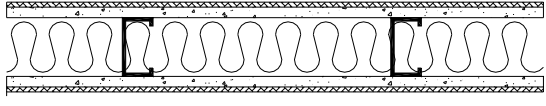
Source	Description	Fire Resistance Rating	Sound Transmission Class		
UL U404 BXUV7	<ul style="list-style-type: none"> 3 1/2" x 20 MSG steel studs spaced at 16" o.c. 3" mineral wool insulation 1 layer 1/2" or 5/8" cementitious board on one side 1 layer 5/8" thick gypsum board on other side 		1 h	<50*	
		<ul style="list-style-type: none"> 3 1/2" x 20 MSG steel studs spaced at 16" o.c. 3" mineral wool insulation 2 layers 5/8" gypsum board on one side inner layer of 5/8" thick gypsum, outer layer of 1/2" or 5/8" cementitious board on other side 	 <p>Configuration A</p>	2 h	<50*
		<ul style="list-style-type: none"> 3 1/2" x 20 MSG steel studs spaced at 16" o.c. 3" mineral wool insulation 2 layers 1/2" or 5/8" cementitious board on one side 2 layers 5/8" thick gypsum board on other side 	 <p>Configuration B</p>	2 h	<50*
UL U407 USG840321 BXUV7	<ul style="list-style-type: none"> 3 1/2" x 20 MSG steel studs spaced at 16" o.c. 3" mineral wool insulation 5/8" cementitious board, ceramic tiles and exterior finish on either side 		1 h	48	

* Estimated value as per Warnock (2008)

Load Bearing Walls – Underwriters Laboratories Inc.

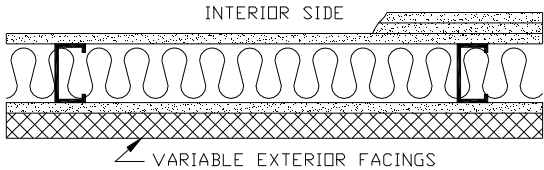
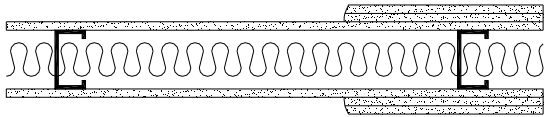
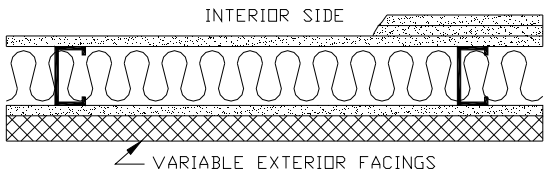
Source	Description	Fire Resistance Rating	Sound Transmission Class
UL U418 BXUV7	<ul style="list-style-type: none"> 3 1/2" or 5 1/2" x 1 1/2" x 18 GSG (0.051" thick) steel stud spaced at 24" o.c. 3 1/2" glass fiber batts gypsum board on interior side (rating listed for thickness of gypsum and number of layers applied) 1 layer of 1/2" gypsum sheathing on exterior side <p>NOTE: Exposed to fire on interior face only</p>	 <p>INTERIOR SIDE</p> <p>VARIABLE EXTERIOR FACINGS</p>	<p>45 min for 1 layer 5/8 in. 1 h for 2 layers 1/2 in. 2 h for 3 layers 1/2 in.</p> <p>- - -</p>
UL U423 a) USG810518 b) USG810519 c) USG811006 BXUV7	<ul style="list-style-type: none"> 3 1/2" x 20 MSG steel stud spaced at 24" o.c. optional glass fiber or mineral wool insulation optional steel resilient channels spaced 24" o.c. gypsum board on each side (rating listed for thickness of gypsum and number of layers applied) <p>* 80% of Design Load. ** 2" mineral wool insulation</p>		<p>45 min for 1 layer 1/2 in. 1 h for 1 layer 5/8 in. 1-1/2 h for 2 layers 1/2 in. * 2 h for 2 layers 5/8 in. ** 2 h for 2 layers 3/8 in. 2 h for 3 layers 1/2 in. 2 h for 2 layers 3/4 in.</p> <p>41^a (RFB 2") 40^b (NI) - - 48^c (RFB 2") - -</p>
UL U424 BXUV7	<ul style="list-style-type: none"> 3 1/2" x 1 1/2" x 20 MSG steel stud spaced at 24" o.c. optional glass fiber or mineral wool insulation optional steel resilient channels spaced 24" o.c. gypsum board on interior side (rating listed for thickness of gypsum and number of layers applied) 1 layer of 1/2" or 5/8" gypsum board on exterior side <p>NOTE: Exposed to fire on interior face only</p>	 <p>INTERIOR SIDE</p> <p>VARIABLE EXTERIOR FACINGS</p>	<p>45 min for 1 layer 5/8 in. 1 h for 2 layers 1/2 in. 1-1/2 h for 2 layers 5/8 in. 2 h for 3 layers 1/2 in. 2 h for 2 layers 3/4 in.</p> <p>- - - -</p>

Load Bearing Walls – Underwriters Laboratories Inc.

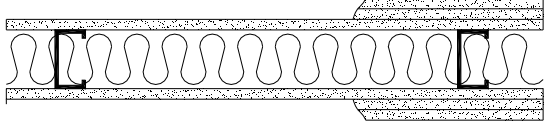
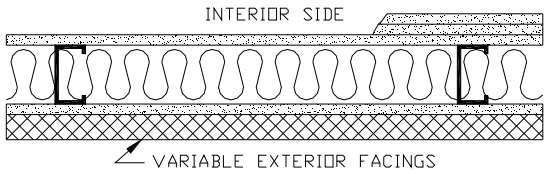
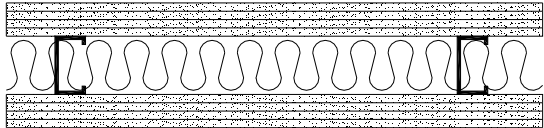
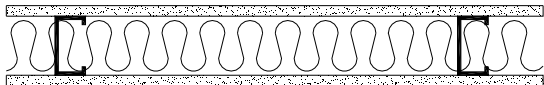
Source	Description	Fire Resistance Rating	Sound Transmission Class
UL U425 Interior Walls a) USG811009 b) USG811006 BXUV7	<ul style="list-style-type: none"> 3 1/2" x 20 MSG steel stud spaced at 24" o.c. optional glass fiber or mineral wool insulation optional steel resilient channels spaced 24" o.c. gypsum board on each side (rating listed for thickness of gypsum and number of layers applied) * 80% of Design Load		
		45 min for 1 layer 1/2 in. 1 h for 1 layer 5/8 in. 1-1/2 h for 2 layers 1/2 in. * 2 h for 2 layers 5/8 in. 2 h for 3 layers 1/2 in. 2 h for 2 layers 3/4 in.	- - 49 ^a (RFB 2") 48 ^b (RFB 2") - -
UL U425 Exterior Walls a) USG811009 b) USG811006 BXUV7	<ul style="list-style-type: none"> 3 1/2" x 20 MSG steel stud spaced at 24" o.c. glass fiber or mineral wool insulation optional steel resilient channels spaced 24" o.c. gypsum board on interior side (rating listed for thickness of gypsum and number of layers applied) 1 layer of 1/2" or 5/8" exterior gypsum sheathing on exterior side NOTE: Exposed to fire on interior face only.		
		45 min for 1 layer 5/8 in. 1 h for 2 layers 1/2 in. 1-1/2 h for 2 layers 5/8 in. 2 h for 3 layers 1/2 in. 2 h for 2 layers 3/4 in.	- 49 ^a (RFB 2") 48 ^b (RFB 2") - -
UL U426 BXUV7	<ul style="list-style-type: none"> 3 1/2" x 20 MSG steel stud spaced at 24" o.c. optional mineral wool or spray applied cellulose insulation 4 layers of 1/2" gypsum board on each side 		
		3 h	-
UL U432 BXUV7	<ul style="list-style-type: none"> 3 1/2" x 20 MSG steel stud spaced at 24" o.c. optional glass fiber or mineral wool insulation 5/8" gypsum board on each side 		
		1 h	-

Load Bearing Walls – Underwriters Laboratories Inc.

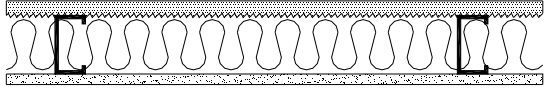
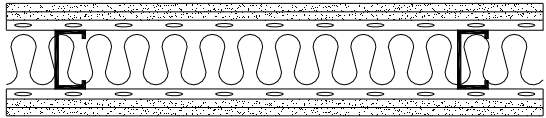
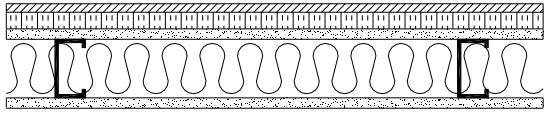
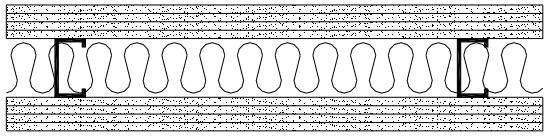
Source	Description	Fire Resistance Rating	Sound Transmission Class
UL U434 BXUV7	<ul style="list-style-type: none"> 3 1/2" x 20 MSG steel stud spaced at 24" o.c. optional glass fiber or mineral wool insulation 5/8" gypsum board on one side metal lath and 2 coat 7/8" portland cement plaster 		
		1 h	<50* (RFB 3 1/2")
UL U440 a) USG811009 b) SA840715 BXUV7	<ul style="list-style-type: none"> 3 1/2" x 20 MSG steel stud spaced at 24" o.c. optional steel resilient channels spaced 24" o.c. optional mineral wool insulation 2 layers of 1/2" gypsum board on each side 		
		1 h	49 ^a (NRC RFB 2") 51 ^b (one RC NI)
UL U460 BXUV7	<ul style="list-style-type: none"> 3 1/2" x 20 MSG steel stud spaced at 24" o.c. 3 1/2" mineral wool insulation 5/8" gypsum board on interior side 5/8" gypsum sheathing on exterior side 1" rigid polystyrene or polyisocyanurate insulation on exterior side 1/2" plywood sheathing on exterior side 		
		1 h	-
UL U462 BXUV7	<ul style="list-style-type: none"> 3 1/2" x 20 MSG steel stud spaced at 24" o.c. optional mineral wool insulation 4 layers of 1/2" gypsum board on each side 		
		3 h	-

* Estimated value as per Warnock (2008)

Load Bearing Walls – Underwriters Laboratories Inc.

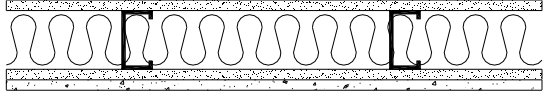
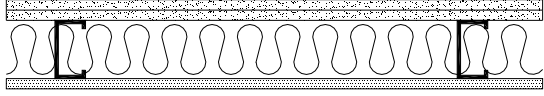
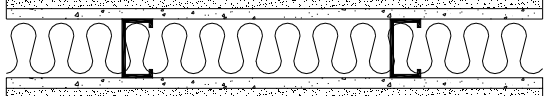
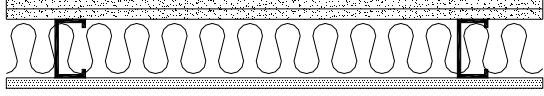
Source	Description	Fire Resistance Rating	Sound Transmission Class
UL U473 BXUV7	<ul style="list-style-type: none"> 3 1/2" x 20 MSG steel stud spaced at 16" o.c. min 3" insulation 1 layer 5/8" gypsum board on one side 1 layer 5/8" gypsum board and 1 layer 1/2" or 5/8" cementitious board on other side 		
		1 h	<50* (CEMBRD 1/2" RFB 3")
UL U477 BXUV7	<ul style="list-style-type: none"> 3 5/8" x 1 5/8" x 20 MSG steel stud spaced at 24" o.c. 3 1/2" mineral wool or spray applied cellulose insulation 2 layers 5/8" gypsum board on one side 1 layer 0.591" (15 mm) thick mineral and fiber board on other side 		
		2 h	-
UL U485 BXUV7	<ul style="list-style-type: none"> 3 1/2" x 20 MSG steel studs spaced at 16" o.c. 3" min "Thermafiber" insulation inner layer 1/2" or 5/8" cementitious board and outer layer 5/8" thick gypsum board on either side 		
		1 h	-
UL U487 BXUV7	<ul style="list-style-type: none"> 3 5/8" x 1 5/8" x 20 MSG steel stud spaced at 24" o.c. 3" mineral wool insulation 2 layers 5/8" gypsum board on one side 1 layer 17 mm thick mineral and fiber board on other side 		
		1 h	<50*

* Estimated value as per Warnock (2008)

Load Bearing Walls – Underwriters Laboratories Inc.

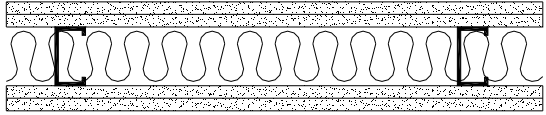
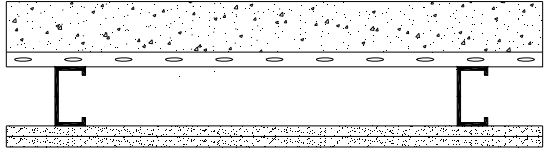
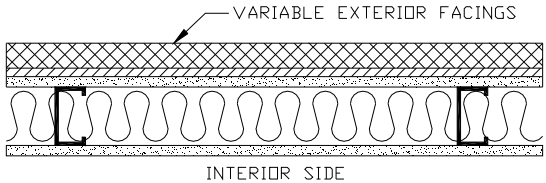
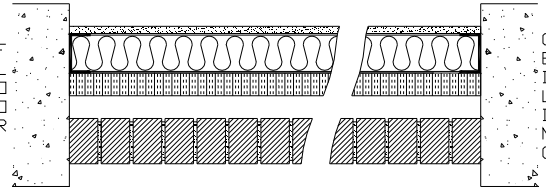
Source	Description	Fire Resistance Rating	Sound Transmission Class
UL U490 BXUV7	<ul style="list-style-type: none"> 3 1/2" x 1 5/8" x 20 MSG steel stud spaced at 24" o.c. 3" mineral wool insulation for 3h 3" mineral wool insulation with minimum 4 pcf for 4h 2 layers 3/4" gypsum board on each side 		
		3 h 4 h	<50* <50*
UL V420 BXUV7	<ul style="list-style-type: none"> 3 1/2" x 20 MSG steel stud spaced at 24" o.c. min 3" thick and max 2' wide precast autoclaved aerated concrete panels on one side 7/8" furring channels spaced 24" o.c. on one side 2 layers of 5/8" gypsum board on other side 		
		2 h	-
UL V432 BXUV7	<ul style="list-style-type: none"> 3 1/2" x 20 MSG steel stud spaced at 24" o.c. glass fiber or mineral wool insulation 5/8" gypsum sheathing on exterior side optional min 7/16" wood structural panel sheathing on exterior side 5/8" gypsum board on interior side <p>NOTE: Exposed to fire on interior face only.</p>		
		1 h	-
UL V434 BXUV7	<ul style="list-style-type: none"> 3 1/2" x 20 MSG steel stud spaced at 24" o.c. 3 1/2" glass fiber or mineral wool insulation 1 layer 5/8" gypsum board on one side 1 layer max 2" foamed plastic board on other side 4" brick veneer 		
		1 h	-

* Estimated value as per Warnock (2008)

Load Bearing Walls – Underwriters Laboratories Inc.

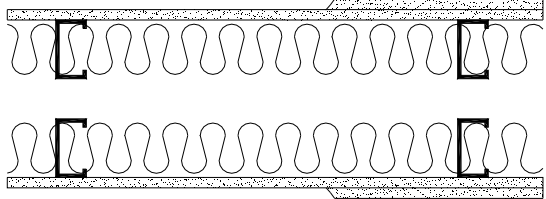
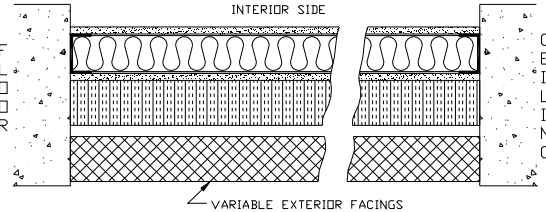
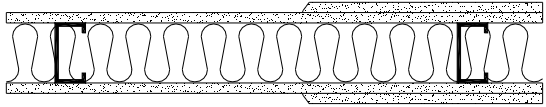
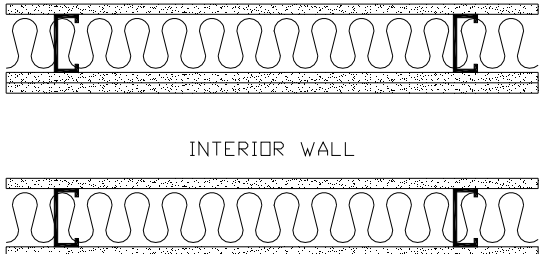
Source	Description	Fire Resistance Rating	Sound Transmission Class
UL V446 BXUV7	<ul style="list-style-type: none"> double wall system with 3 1/2" x 1 5/8" x 0.034" thick galv steel stud spaced at 24" o.c. any glass fiber insulation with UL Classification Marking with min. density of 0.5 pcf 1 or 2 layers of 5/8" gypsum board on each side <p>** 80% of Design Load</p>	 <p>**1 h for 1 - 5/8" 2 h for 2 - 5/8"</p>	<p>58* (AIR 1") 59* (AIR 2") 68* (AIR 1") 69* (AIR 2")</p>
UL V454	<ul style="list-style-type: none"> 3 1/2" x 20 MSG steel studs spaced at 24" o.c. optional glass fiber or mineral wool insulation filling stud cavity 1 layer 5/8" gypsum board on each side 1 layer max 4" foamed plastic board on one side 	 <p>1 h</p>	-
UL V457	<ul style="list-style-type: none"> 3 5/8" x 1 5/8" x 20 MSG proprietary steel studs (Marino\WARE) spaced at 24" o.c. 3 1/2" glass fiber insulation with min. density of 1.0 pcf 1 hour - 1 layer 5/8" gypsum board on each side 2 hour – 2 layers 5/8" gypsum board on each side 	 <p>1 h 2 h</p>	-
UL V458	<ul style="list-style-type: none"> 3 5/8" x 18 MSG steel studs spaced at 24" o.c. 3 1/2" mineral wool insulation with min. density of 3.5 pcf 1 layer 5/8" gypsum board on each side for exterior walls add 5/8" gypsum sheathing to exterior side 	 <p>45 min</p>	-

* Estimated value as per Warnock (2008)

Load Bearing Walls – Underwriters Laboratories Inc.

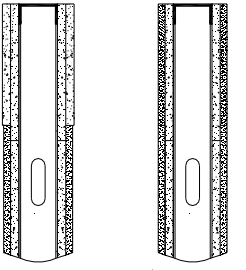
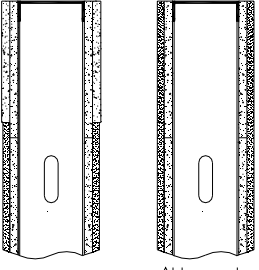
Source	Description	Fire Resistance Rating	Sound Transmission Class
UL V465	<ul style="list-style-type: none"> • 3 1/2" x 1 5/8" x 20 MSG steel stud spaced at 24" o.c. • 3 1/2" nominal thickness glass fibre insulation friction fit in stud cavity • 3/4" thick structural cement-fibre units, designated "Fortacrete", one layer on each side and two layers on each side of stud top wall • 5/8" gypsum board, face layer on each side <p>Alternate Installation</p> <ul style="list-style-type: none"> • 3/4" thick structural cement-fibre units, designated "Fortacrete", one layer on each side • 5/8" gypsum board, entire face layer on each side 	 <p style="text-align: center;">Alternate Installation</p> <p style="text-align: center;">Vertical Section</p>	-
UL V471	<ul style="list-style-type: none"> • 6" x 1 5/8" x 18 MSG steel stud spaced at 24" o.c. • 5 1/2" nominal thickness glass fibre insulation friction fit in stud cavity • 3/4" thick structural cement-fibre units, designated "Fortacrete", one layer on each side and two layers on each side of stud top wall • 5/8" gypsum board, face layer on each side <p>Alternate Installation</p> <ul style="list-style-type: none"> • 3/4" thick structural cement-fibre units, designated "Fortacrete", one layer on each side • 5/8" gypsum board, entire face layer on each side 	 <p style="text-align: center;">Alternate Installation</p> <p style="text-align: center;">Vertical Section</p>	-
		2 h	-
		3 h	-

Load Bearing Walls – Underwriters Laboratories Inc.

Source	Description	Fire Resistance Rating	Sound Transmission Class
UL V478 BXUV7	<ul style="list-style-type: none"> 3 1/2" x 20 MSG steel stud spaced at 24" o.c. optional glass fiber or mineral wool insulation optional on one or both sides, steel resilient channels spaced 24" o.c. gypsum board on each side (rating listed for thickness of gypsum and number of layers applied) <p>* 80% of Design Load. ** 2" mineral wool insulation</p>		
		45 min for 1 layer 1/2 in. 1 h for 1 layer 5/8 in. 1-1/2 h for 2 layers 1/2 in. * 2 h for 2 layers 5/8 in. ** 2 h for 2 layers 5/8 in. 2 h for 3 layers 1/2 in. 2 h for 2 layers 3/4 in.	- - - - - -
UL V479 BXUV7	<ul style="list-style-type: none"> 3 1/2" x 1 1/2" x 20 MSG steel stud spaced at 24" o.c. optional glass fiber or mineral wool insulation optional steel resilient channels spaced 24" o.c. gypsum board on interior side (rating listed for thickness of gypsum and number of layers applied) 1 layer of 1/2" or 5/8" gypsum board on exterior side <p>NOTE: Exposed to fire on interior face only</p>		
		45 min for 1 layer 5/8 in. 1 h for 2 layers 1/2 in. 1-1/2 h for 2 layers 5/8 in. 2 h for 3 layers 1/2 in. 2 h for 2 layers 3/4 in.	- - - - -
UL V480 BXUV7	<ul style="list-style-type: none"> 3 1/2" x 20 MSG steel studs spaced at 24" o.c. optional glass fiber or mineral wool insulation 5/8" gypsum board on each side 		
		1 h	-

Load Bearing Walls – Gypsum Association

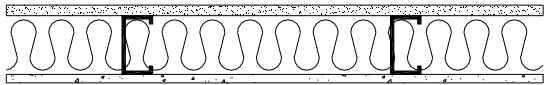
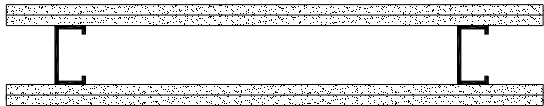
Source	Description	Fire Resistance Rating	Sound Transmission Class
GA WP1417	<ul style="list-style-type: none"> • 3 1/2" x 20 gage steel stud spaced at 16" o.c. • 3" mineral fiber insulation • 1 layer 5/8" Type X gypsum board on one side • 1 layer 1/2" cementitious board on other side 		
		1 h	-
GA WP1716 NGC 2250	<ul style="list-style-type: none"> • 3 1/2" x 20 gage steel stud spaced at 24" o.c. • 2 layers 5/8" Type X gypsum board on each side 		
		2 h	40 to 44

ROOF/CEILING ASSEMBLIES

Roof/Ceiling – Underwriters Laboratories of Canada

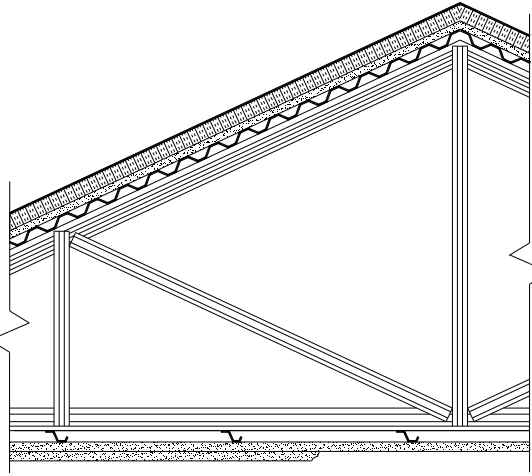
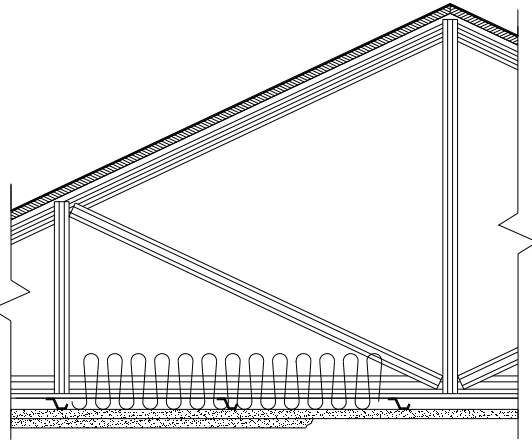
Source	Description	Fire Resistance Rating
<p>ULC R500</p>	<ul style="list-style-type: none"> • roof covering • foamed plastic insulation boards, 1" for 1h, 2" for 1½ h & 4" for 2h • gypsum sheathing min. 12.7 mm thick • steel roof deck corrugated or fluted, min. 0.76 mm thick • trusses spaced a max. 1220 mm o.c. • proprietary pre-fabricated light gauge steel truss system, Ultra-Span by Aegis Metal Framing • resilient or furring channels spaced 406 mm o.c. • 1 & 1½ hour - 1 layer of 15.9 mm gypsum board on ceiling side • 2 hour - 2 layers of 15.9 mm gypsum board on ceiling side 	<div style="text-align: center;">  </div> <div style="text-align: center; margin-top: 10px;"> <p>1 h 1-½ h 2 h</p> </div>
<p>ULC R501</p>	<ul style="list-style-type: none"> • roof covering • nom. 18 mm thick wood structural panels • trusses spaced a max. of 1220 mm o.c. • proprietary pre-fabricated light gauge steel truss system, Ultra-Span by Aegis Metal Framing • min. 241 mm thick glass fibre insulation for 1½h, any thickness mineral wool or glass fibre insulation for 1 h, optional • resilient or furring channels spaced 406 mm o.c. • 1 hour - 1 layer of 15.9 mm gypsum board on ceiling side • 1½ hours - 2 layers of 15.9 mm gypsum board on ceiling side 	<div style="text-align: center;">  </div> <div style="text-align: center; margin-top: 10px;"> <p>1 h 1-½ h</p> </div>

Roof/Ceiling – Underwriters Laboratories Inc.

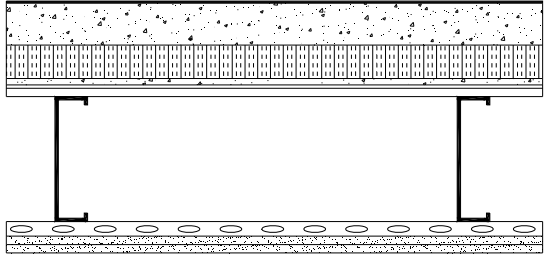
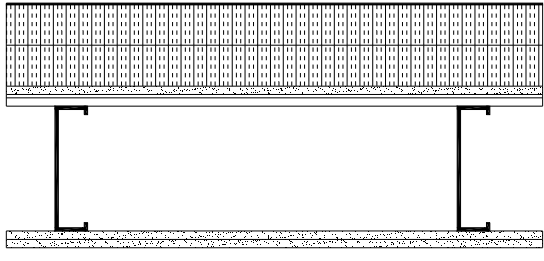
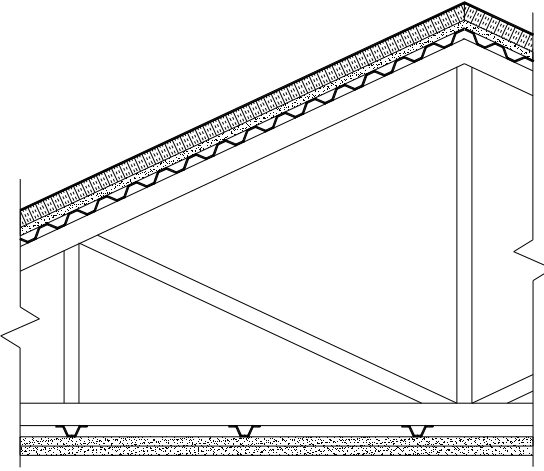
Source	Description	Fire Resistance Rating
UL P511	<ul style="list-style-type: none"> • crushed stone & roof covering • insulating concrete, min. 2" • foamed plastic insulation boards, thickness 1" to 8" • 28 MSG roof deck, $\frac{9}{16}$" deep • $7\frac{1}{4}$" x 18 MSG steel roof joist spaced 24" o.c. • furring channels spaced 24" o.c. • 2 layers of $\frac{1}{2}$" gypsum board 	 <p style="text-align: center;">1 h</p>
UL P512	<ul style="list-style-type: none"> • roof covering • 2 layers of $2\frac{7}{16}$" mineral & fiber boards • gypsum sheathing $\frac{1}{2}$" thick • 28 MSG roof deck, $\frac{9}{16}$" deep • $7\frac{1}{4}$" x 18 MSG steel roof joist spaced 24" o.c. • 2 layers of $\frac{1}{2}$" gypsum board 	 <p style="text-align: center;">1 h</p>
UL P515	<ul style="list-style-type: none"> • roof covering • foamed plastic, mineral wool, glass fiber or perlite insulation boards, 1" min. thickness and no limit on max. overall thickness • gypsum sheathing $\frac{1}{2}$" thick • steel roof deck corrugated or fluted, min. 28 MSG • trusses spaced a max. 24" or 48" o.c. • truss chord & web sections designed to AISI Specifications • resilient or furring channels spaced 24" o.c. • 2 layers of $\frac{5}{8}$" gypsum board on ceiling side 	 <p style="text-align: center;">1 h</p>

Roof/Ceiling – Underwriters Laboratories Inc.

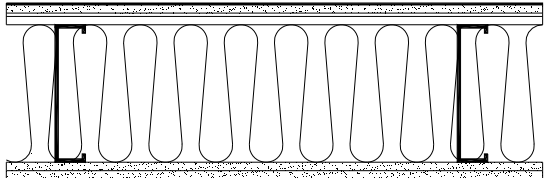
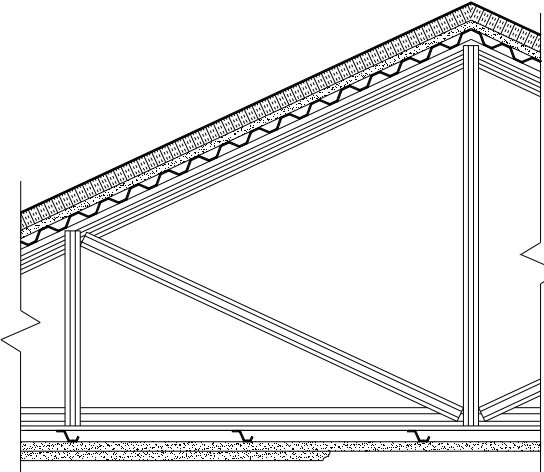
Source	Description	Fire Resistance Rating
UL P518	<ul style="list-style-type: none"> • roof covering • gypsum sheathing 1/2" thick • 28 MSG roof deck, 9/16" deep • 8" x 18 MSG steel roof joist spaced at 24" o.c. • 8" thick glass fiber insulation • 2 layers of 1/2" gypsum board 	 <p style="text-align: center;">1 h</p>
UL P521	<ul style="list-style-type: none"> • roof covering • foamed plastic insulation boards, 1" for 1h, 2" for 1½ h & 4" for 2h • gypsum sheathing min. 1/2" thick • steel roof deck corrugated or fluted, min. 22 MSG • trusses spaced a max. 48" o.c. • proprietary pre-fabricated light gauge steel truss system, Ultra-Span by Aegis Metal Framing • resilient or furring channels spaced 16" o.c. • 1 & 1½ hour - 1 layer of 5/8" gypsum board on ceiling side • 2 hour - 2 layers of 5/8" gypsum board on ceiling side 	 <p style="text-align: center;">1 h 1-½ h 2 h</p>

Roof/Ceiling – Underwriters Laboratories Inc.

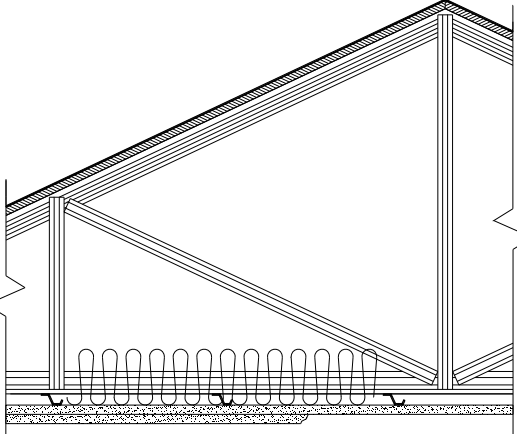
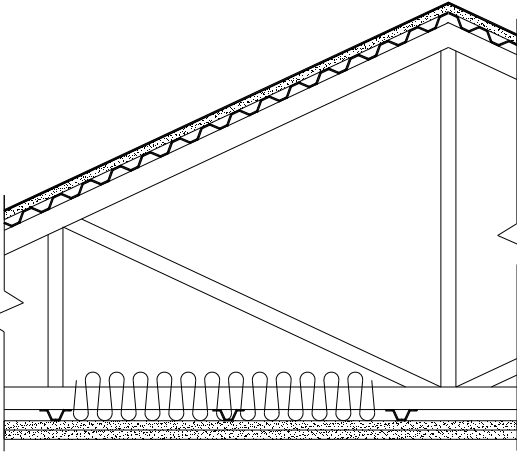
Source	Description	Fire Resistance Rating
<p>UL P523</p>	<ul style="list-style-type: none"> • roof covering • nom. $\frac{23}{32}$" thick wood structural panels • trusses spaced a max. of 48" o.c. • proprietary pre-fabricated light gauge steel truss system, Ultra-Span by Aegis Metal Framing • min. 9½" thick glass fiber insulation for 1½h, any thickness mineral wool or glass fiber insulation for 1 h, optional • resilient or furring channels spaced 16"o.c. • 1 hour - 1 layer of 5⁄8" gypsum board on ceiling side • 1½ hours - 2 layers of 5⁄8" gypsum board on ceiling side 	 <p style="text-align: center;">1 h 1-½ h</p>
<p>UL P524</p>	<ul style="list-style-type: none"> • roof covering • gypsum sheathing ½" thick • steel roof deck corrugated or fluted, min. 28 MSG • trusses spaced a max. 24" or 48" o.c. • truss chord & web sections designed to AISI Specifications • resilient or furring channels spaced 24"o.c. • 8" thick glass fiber insulation • 2 layers of 5⁄8" gypsum board on ceiling side 	 <p style="text-align: center;">1 h</p>

Roof/Ceiling – Underwriters Laboratories Inc.

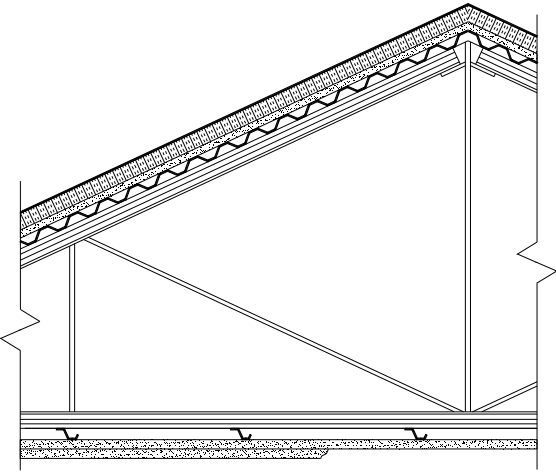
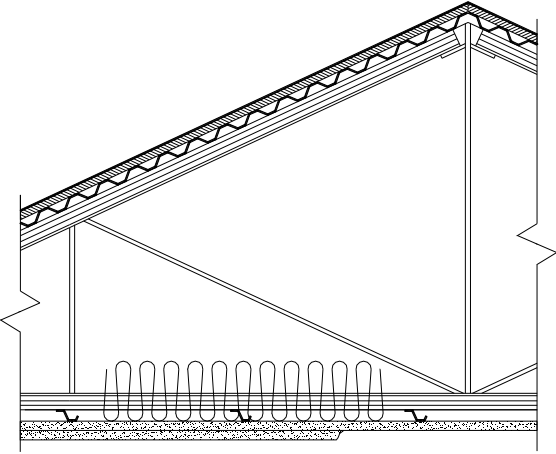
Source	Description	Fire Resistance Rating
<p>UL P525</p>	<ul style="list-style-type: none"> • roof covering • foamed plastic insulation boards, no minimum for 1h, 2" for 1½ h & 4" for 2h • gypsum sheathing min. ½" thick • steel roof deck corrugated or fluted, min. 22 MSG • trusses spaced a max. 48" o.c. • proprietary pre-fabricated light gauge steel truss system, TrusSteel by Alpine Engineered Products, Inc. • resilient or furring channels spaced 16"o.c. • 1 & 1½ hours - 1 layer of 5/8" gypsum board on ceiling side • 2 hours - 2 layers of 5/8" gypsum board on ceiling side 	<div style="text-align: center;">  </div> <div style="text-align: center; margin-top: 10px;"> <p>1 h 1-½ h 2 h</p> </div>
<p>UL P526</p>	<ul style="list-style-type: none"> • roof covering • nom. 23/32" thick plywood sheathing • trusses spaced a max. 24" or 48" o.c. • proprietary pre-fabricated light gauge steel truss system, TrusSteel by Alpine Engineered Products, Inc. • resilient or furring channels spaced 16"o.c. • min. 9½" thick mineral wool or glass fiber insulation for 1½h, any thickness mineral wool or glass fiber insulation for 1 h, optional • 1 hour – 1 layer of 5/8" gypsum board on ceiling side • 1½ hours - 2 layers of 5/8" gypsum board on ceiling side 	<div style="text-align: center;">  </div> <div style="text-align: center; margin-top: 10px;"> <p>1 h 1-½ h</p> </div>

Roof/Ceiling – Underwriters Laboratories Inc.

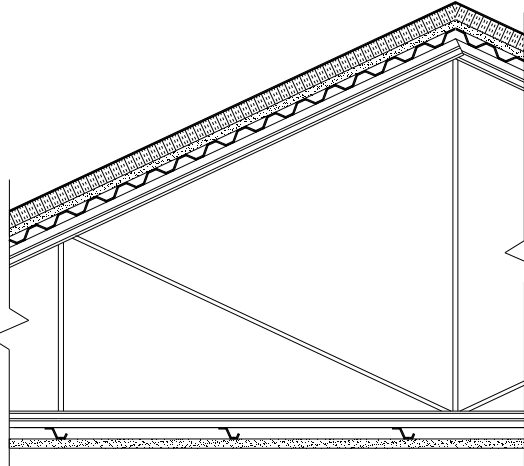
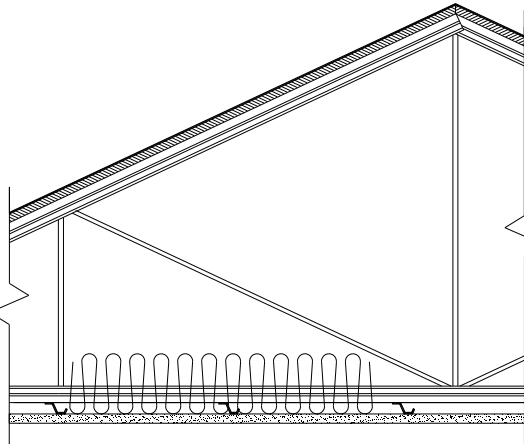
Source	Description	Fire Resistance Rating
<p>UL P527</p>	<ul style="list-style-type: none"> • roof covering • foamed plastic insulation boards, no minimum for 1h & 2" for 1½ h • gypsum sheathing min. ½" thick • steel roof deck corrugated or fluted, min. 22 MSG • trusses spaced a max. 48" o.c. • proprietary pre-fabricated light gauge steel truss system, Amkey System by Allied Studco • resilient channels spaced 16" o.c. • 1 layer of 5/8" gypsum board on ceiling side 	 <p style="text-align: center;">1 h 1-½ h</p>
<p>UL P528</p>	<ul style="list-style-type: none"> • roof covering • nom. 23/32" thick plywood sheathing • trusses spaced a max. 24" or 48" o.c. • proprietary pre-fabricated light gauge steel truss system, Amkey System by Allied Studco • resilient channels spaced 16" o.c. • mineral wool or glass fiber insulation • 1 layer of 5/8" gypsum board on ceiling side 	 <p style="text-align: center;">1 h</p>

Roof/Ceiling – Underwriters Laboratories Inc.

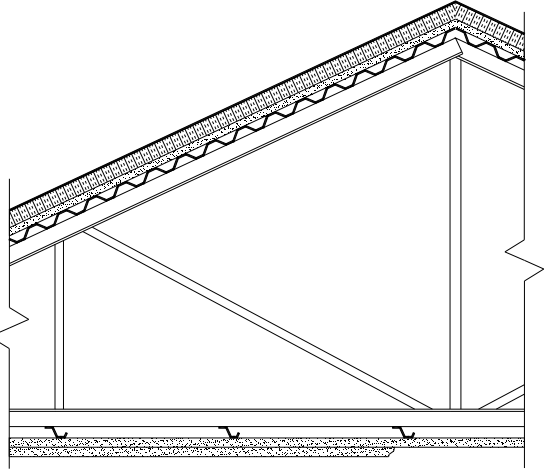
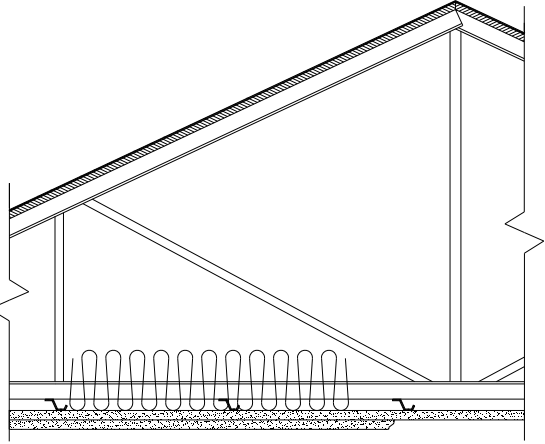
Source	Description	Fire Resistance Rating
<p>UL P536</p>	<ul style="list-style-type: none"> • roof covering • foamed plastic insulation boards, no minimum for 1 h, 1" for 1½ h & 2.6" for 2 h • gypsum sheathing min. ½" thick • steel roof deck corrugated or fluted, min. 22 MSG • trusses spaced a max. 48" o.c. • proprietary pre-fabricated light gauge steel truss system, Gus Truss by Nucon Steel Corporation • resilient channels spaced 16" o.c. • 1 & 1½ hours - 1 layer of 5/8" gypsum board on ceiling side • 2 hours - 2 layers of 5/8" gypsum board on ceiling side 	 <p style="text-align: center;">1 h 1-½ h 2 h</p>
<p>UL P537</p>	<ul style="list-style-type: none"> • roof covering • nom. 23/32" thick wood structural panels • trusses spaced a max. 48" o.c. • proprietary pre-fabricated light gauge steel truss system, Gus Truss by Nucon Steel Corporation • resilient or furring channels spaced 16" o.c. • min. 9½" thick glass fiber insulation for 1½ h, any thickness mineral wool or glass fiber insulation for 1 h, optional • 1 hour - 1 layer of 5/8" gypsum board on ceiling side • 1½ hours - 2 layers of 5/8" gypsum board on ceiling side 	 <p style="text-align: center;">1 h 1-½ h</p>

Roof/Ceiling – Underwriters Laboratories Inc.

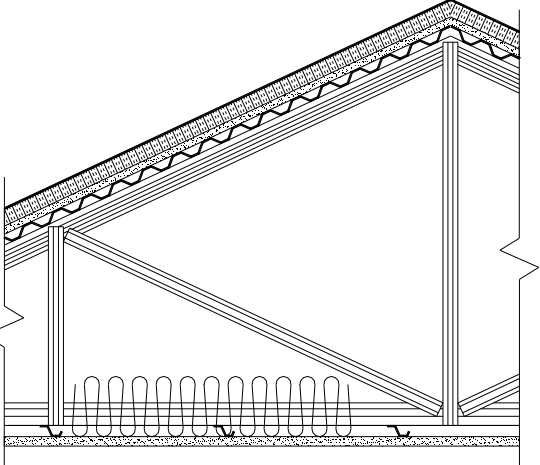
Source	Description	Fire Resistance Rating
UL P540	<ul style="list-style-type: none"> • roof covering • foamed plastic, mineral wool, glass fiber or perlite insulation boards, no min. thickness and no limit on max. overall thickness • gypsum sheathing min. ½" thick • steel roof deck corrugated or fluted, min. 22 MSG • trusses spaced a max. 48" o.c. • proprietary pre-fabricated light gauge steel truss systems, <ol style="list-style-type: none"> 1. Ultra-span by Aegis Metal Framing 2. Amkey System by Allied Studco 3. Versa-Truss by Dale/Incor 4. Strong-Span by Hexaport International Ltd. 5. Gus Truss by Nucon Steel Corporation 6. TrusSteel by Alpine Engineered Products • resilient or furring channels spaced 16" o.c. • any thickness mineral wool or glass fiber insulation • 1 layer of 5/8" gypsum board on ceiling side 	 <p style="text-align: center;">1 h</p>

Roof/Ceiling – Underwriters Laboratories Inc.

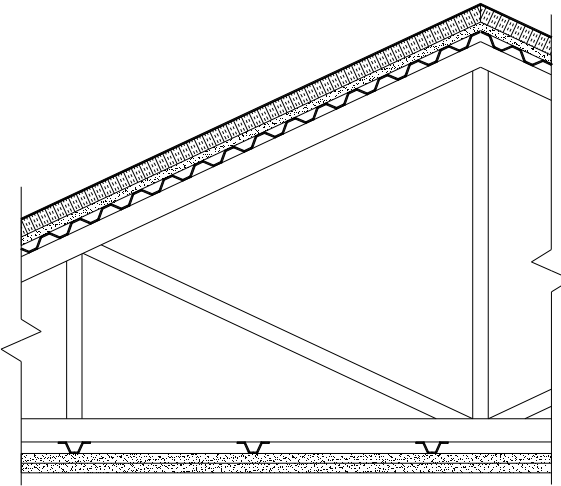
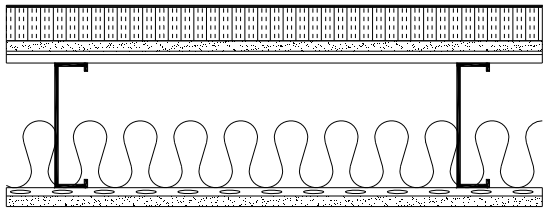
Source	Description	Fire Resistance Rating
UL P541	<ul style="list-style-type: none"> • roof covering • foamed plastic, mineral wool, glass fiber or perlite insulation boards, 1" min. thickness and no limit on max. overall thickness • gypsum sheathing ½" thick • steel roof deck corrugated or fluted, min. 28 MSG • trusses spaced a max. 24" or 48" o.c. • truss chord & web sections designed to AISI Specifications • resilient channels spaced 24" o.c. • 2 layers of 5/8" gypsum board on ceiling side 	 <p style="text-align: center;">1 h</p>
UL P546	<ul style="list-style-type: none"> • roof covering • foamed plastic insulation boards, 1" min. thickness and no limit on max. overall thickness • gypsum board ½" or 5/8" thick • 22 MSG roof deck, 9/16" deep • 9¼" x 16 MSG proprietary steel joist (ClarkDietrich) spaced at 24" o.c. • resilient channels spaced 12" o.c. • any glass fiber insulation, min. 3½" and max. 6¼" thick • 1 layer of 5/8" gypsum board on ceiling side 	 <p style="text-align: center;">1 h</p>